



**EERC**<sup>SM</sup>

Critical Challenges.

**Practical Solutions.**



# NEBRASKA INTEGRATED CARBON CAPTURE AND STORAGE PRE-FEASIBILITY STUDY

DE-FE0029186

Neil Wildgust

Energy & Environmental Research Center

U.S. Department of Energy

National Energy Technology Laboratory

Mastering the Subsurface Through Technology Innovation, Partnerships and Collaboration:  
Carbon Storage and Oil and Natural Gas Technologies Review Meeting

August 1–3, 2017

Critical Challenges. **Practical Solutions.**

# TASK AND SUBTASK BREAKDOWN

- *Task 1.0 – Project Management, Planning, and Reporting*
- **Task 2.0 – Regional and Stakeholder Analysis**
- **Task 3.0 – Scenario Analysis**
- **Task 4.0 – Subbasinal Analysis**
- *Task 5.0 – NRAP Validation*

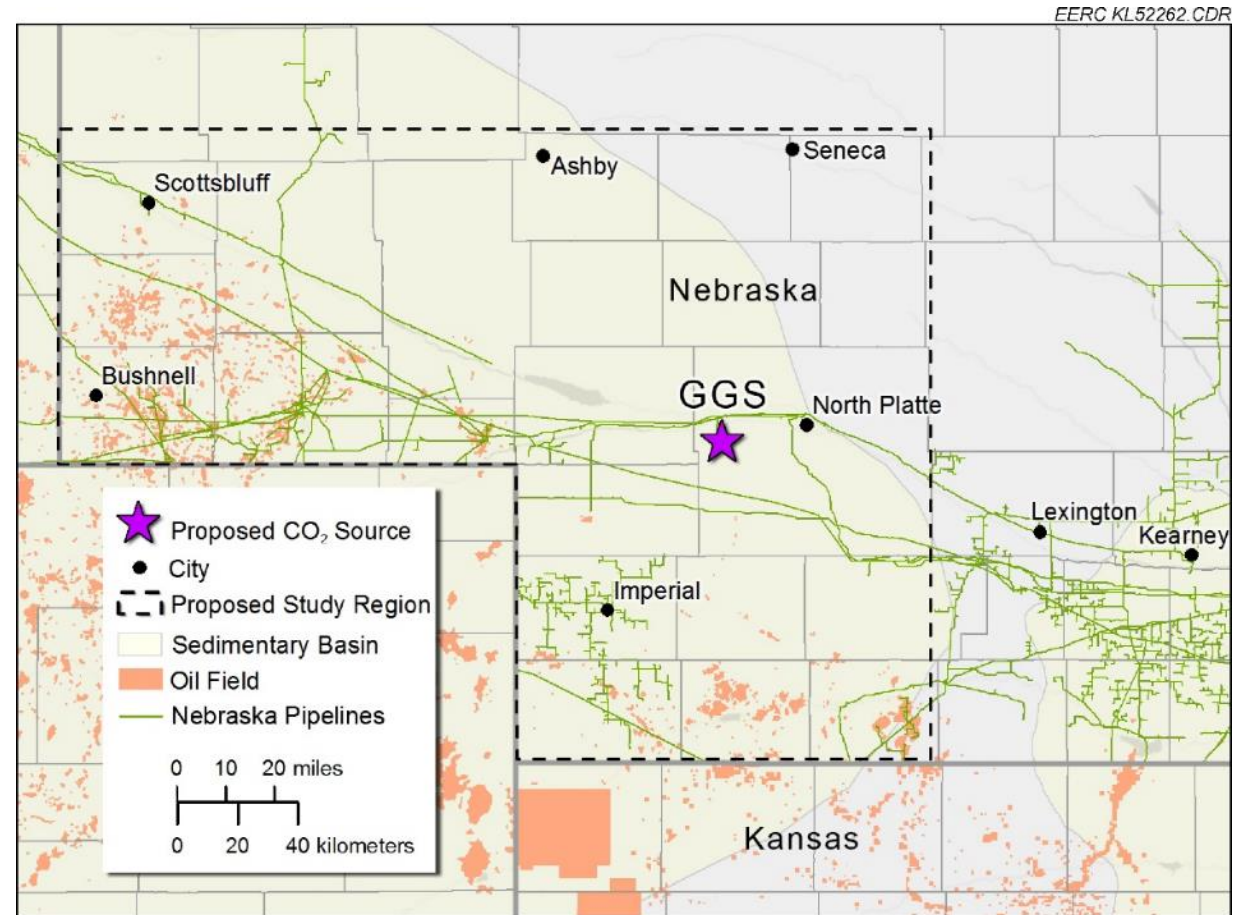



# TASK 2.0 – REGIONAL AND STAKEHOLDER ANALYSIS, cont.

*Assessment of geographic and socioeconomic characteristics specific to the study region in relation to CCS:*

- Subtask 2.3 – Community Impact Analysis
  - Regional demographics
  - Regional public perception and understanding of CCS and related issues
  - Local economic and industrial trends
  - Identify pore space and surface owners
  - Community Outreach Plan
    - ◆ Educate/inform the public, public opinion leaders, and decision makers
    - ◆ Methods to evaluate public perception of CCS and mitigation approaches to any identified potential conflicts

# STAKEHOLDER KICKOFF MEETING, JULY 18, LINCOLN, NEBRASKA

- Presented by EERC (project manager) and Nebraska Public Power District (NPPD) (utility partner)
- 27 attendees
  - Nine representing project management, technical team, and utility partner
  - 18 representing range of interested parties
    - ◆ Policy and regulatory
    - ◆ Oil production
    - ◆ Electricity generation
    - ◆ Ethanol production
    - ◆ University
    - ◆ Capture technology
- CCS basics, CarbonSAFE-Nebraska project details, and attendee perspectives

# TASK 3.0 – SCENARIO ANALYSIS

## *Current Activities:*

- Subtask 3.1 – CO<sub>2</sub> Resource Assessment
  - Using the EPA Facility Level Information on GreenHouse Gases Tool (FLIGHT), searched for all major point sources emitting more than 100,000 tonnes CO<sub>2</sub>/yr within a 50-mi radius of Sutherland, Nebraska.
  - NPPD’s Gerald Gentleman Station is the only one.
  - Determined that solvent scrubbing is the capture technology most likely to be used. Current technical details on the most promising commercial CO<sub>2</sub> capture solvents are being researched.

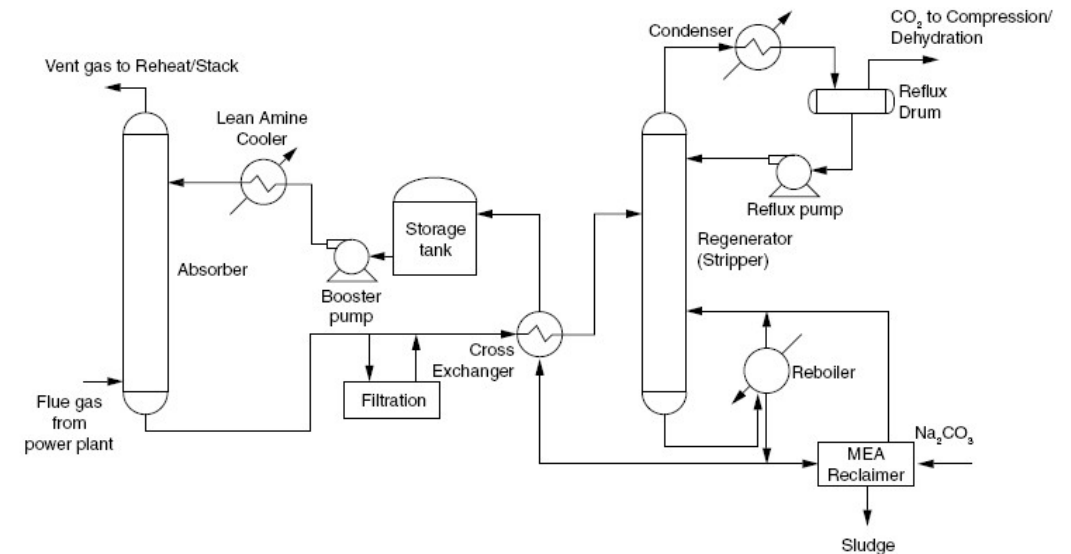

# NPPD'S GERALD GENTLEMAN STATION UNIT 2



Nebraska Public Power District  
*Always there when you need us*

Gerald Gentleman Station Unit 2 (GGS2) will be assumed to provide the CO<sub>2</sub> for this prefeasibility study.

2016 statistics (from EPA Air Markets Program data):

- Dry bottom, wall-fired boiler
- Low-NO<sub>x</sub> burners with overfired air
- Baghouse for particulate control
- Halogenated powdered activated carbon (PAC) injection for mercury control
- Gross load = 3,609,063 MWh
- CO<sub>2</sub> emission = 3.24 million tonnes





# PRELIMINARY INTEGRATED ENVIRONMENTAL CONTROL MODEL (IECM) MODELING RESULTS

- **Major Assumptions:**

- Capture takes place at GGS2 as a retrofit on NPPD-owned property.
- All capture types require installation of a wet flue gas desulfurization (WFGD) unit with a demister.
- Pipeline would be 50 mi in length.
- CO<sub>2</sub> pressure at plant = 2000 psi; at injection site = 1500 psi.
- Use of a flue gas bypass and a 47% overall CO<sub>2</sub> removal efficiency produces 2 million tonnes of CO<sub>2</sub> for injection each year.

Capture Type	Total Levelized Annual Cost, M\$/yr (2014\$)
Baseline	173.9
Baseline + WFGD/demister	200.0
Fluor Econamine FG+	259.4
Cansolv	288.8
Monoethanolamine (MEA)	278.4
Ammonia	284.1
Polymer Membrane	289.4

# TASK 3.0 OTHER ACTIVITIES

## Subtask 3.2 – Financial and Economic Evaluation

- GGS2 is being modeled using Carnegie Mellon IECM V9.5 to provide estimates of the cost associated with capturing, compressing, and transporting 2 million tonnes/yr CO<sub>2</sub>.
- Capital and operating costs are being estimated using the model.
- Subtask 3.3 – State and Federal Incentives and Challenges
  - Identifying policies and permitting requirements specific to Nebraska.
- Subtask 3.4 – Storage Resources Ownership Evaluation
  - Determining the pore space rights in Nebraska.

# TASK 4.0 SUBSURFACE ASSESSMENT

*Evaluation of potential geologic storage locations:*

- Examine geologic storage targets
- Identify reservoirs capable of 50+ million tonnes CO<sub>2</sub> storage and potential injection sites (including EOR)
- Determine the area of review (AOR) – surface and subsurface
- Articulate additional data needs

## → Characterization Plan

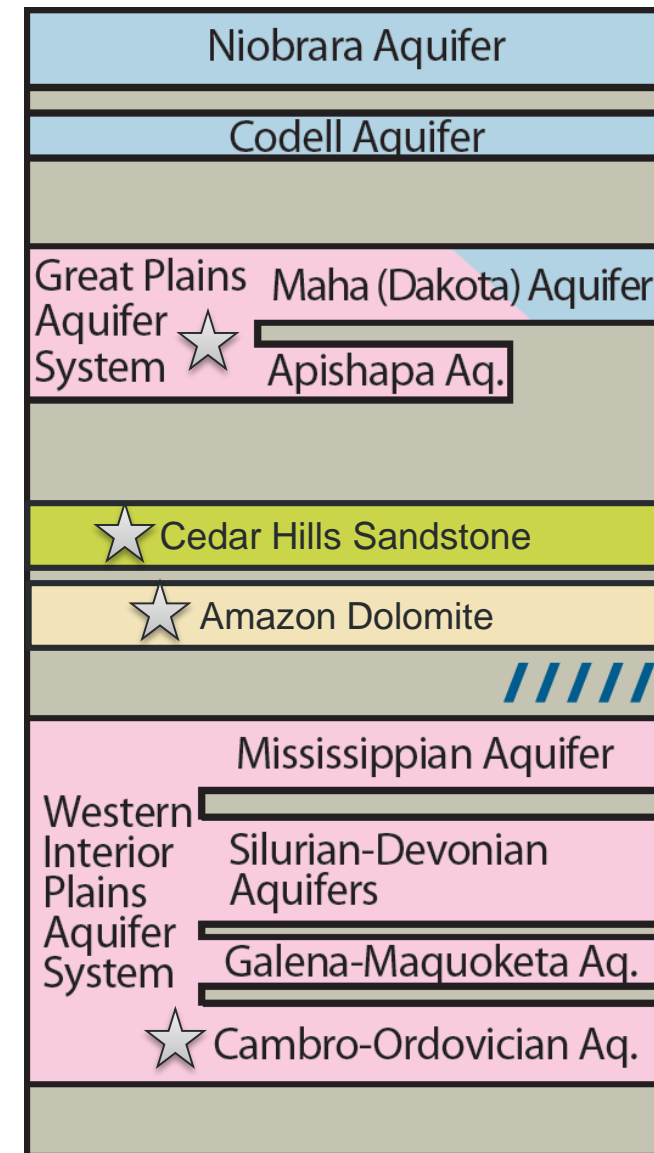

Paleozoic and Mesozoic Aquifers in Nebraska (Korus and Joeckel, 2011; mod.)

### Cedar Hills Thickness

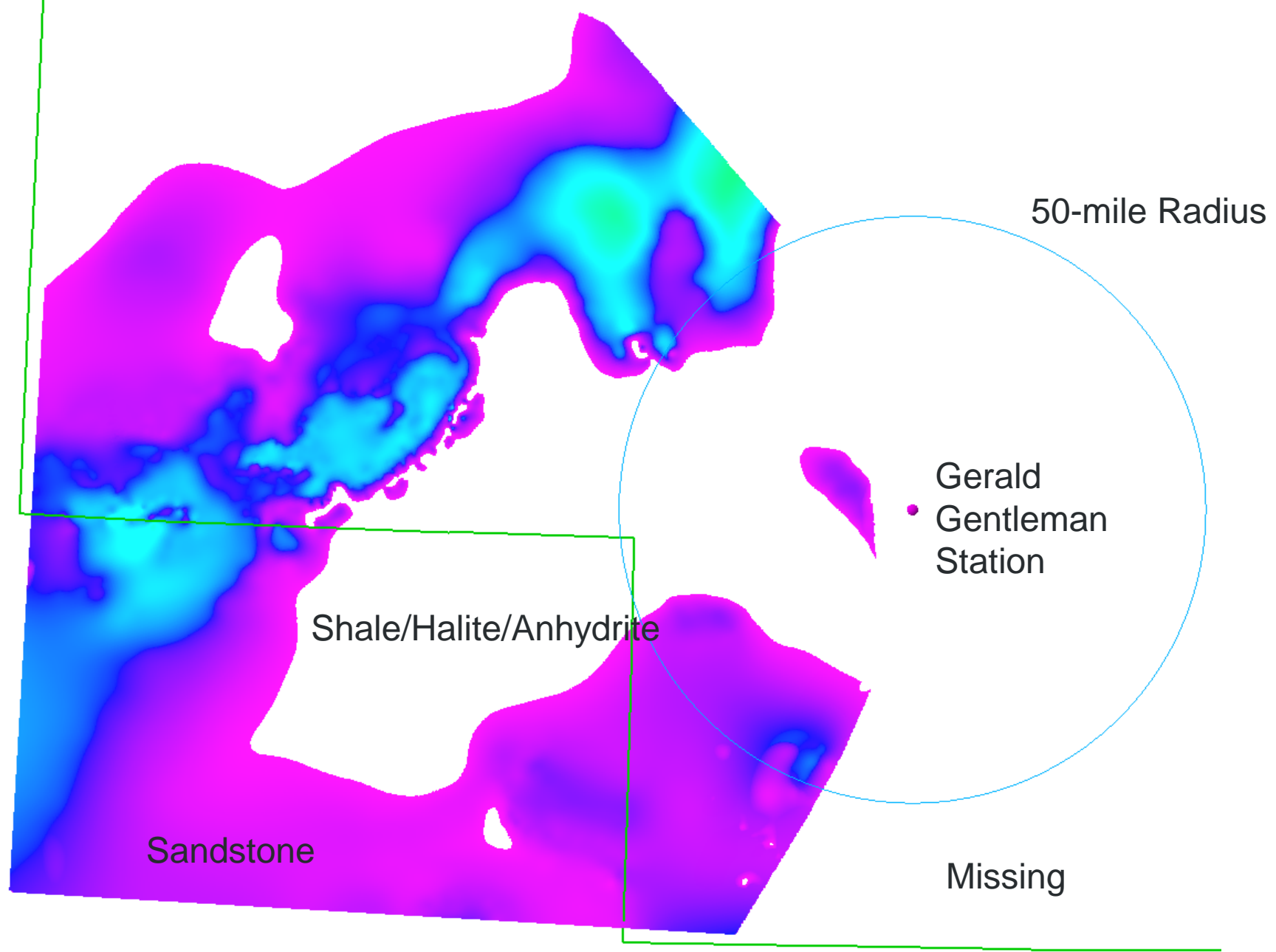
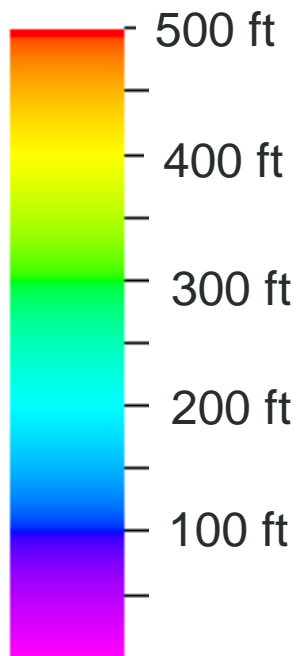

# TASK 5.0 – NRAP VALIDATION

- **Objectives**

- Assessment of National Risk Assessment Partnership (NRAP) tools, providing feedback to DOE and the NRAP team
  - ◆ Select NRAP tools that will be used to independently both simulate long-term leakage and calculate CO<sub>2</sub> and pressure plumes through time.
  - ◆ Other NRAP tools will be used if applicable.

- **Tools selected for an initial assessment**

- Reservoir Reduced-Order Model – Generator (RRROM-Gen) tool
- Reservoir Evaluation and Visualization (REV) tool
- Well Leakage Analysis Tool (WLAT)

**Validated**

**Validated**

**Ongoing work**

# PROJECT SUMMARY

- Synergy opportunities: informal discussions to date with two other CarbonSAFE Phase I projects in the Nebraska/Kansas region.
- Strong interest from stakeholders in understanding CCS potential in Nebraska – positive engagement at kickoff meeting in July.
- Significant geological uncertainty – sparse deep well records.
- Distribution of prospective deep saline formation (DSF) storage resources in Nebraska appears uneven.

# ACKNOWLEDGMENT

This material is based upon work supported by the U.S. Department of Energy National Energy Technology Laboratory under Award No. DE-FE0029186.

## Disclaimer

This presentation was prepared as an account of work sponsored by an agency of the United States Government. Neither the United States Government, nor any agency thereof, nor any of their employees, makes any warranty, express or implied, or assumes any legal liability or responsibility for the accuracy, completeness, or usefulness of any information, apparatus, product, or process disclosed or represents that its use would not infringe privately owned rights. Reference herein to any specific commercial product, process, or service by trade name, trademark, manufacturer, or otherwise does not necessarily constitute or imply its endorsement, recommendation, or favoring by the United States Government or any agency thereof. The views and opinions of authors expressed herein do not necessarily state or reflect those of the United States Government or any agency thereof.

# CONTACT INFORMATION

**Energy & Environmental Research Center**  
University of North Dakota  
15 North 23rd Street, Stop 9018  
Grand Forks, ND 58202-9018

**www.undeerc.org**  
701.777.5193 (phone)  
701.777.5181 (fax)

**Neil Wildgust**  
**Principal CCS Scientist**  
nwildgust@undeerc.org







**THANK YOU!**



# APPENDIX

# PROJECT OVERVIEW: BENEFIT TO THE PROGRAM

## Benefits Statement

This project provides a solution to mitigation of CO<sub>2</sub> emissions from coal-fired electricity generation through investigation of CO<sub>2</sub> capture from flue gas and subsequent permanent geologic storage. The approach described in this pre-feasibility study advances carbon storage research and development by identifying commercial-scale geologic storage sites and generating a pathway to implementation that will be socially acceptable and meet all permitting requirements, including the formation of an engaged, highly qualified CCS coordination team. In addition, the proposed research supports the **DOE Carbon Storage Program's goals** to “**develop and validate technologies to ensure 99 percent storage permanence**” [Goal 1] and to “**develop technologies to improve reservoir storage efficiency while ensuring containment effectiveness**” [Goal 2] by conducting the proposed subbasinal characterization and by utilizing site-screening tools such as NRAP. The DOE program goal to “**support industry's ability to predict CO<sub>2</sub> storage capacity in geologic formations to within ±30 percent**” [Goal 3] will be addressed by integrating characterization data into reservoir models for a commercial-scale geologic storage facility (≥50 million metric tons CO<sub>2</sub>). Information produced will be useful for inclusion in **DOE's Carbon Storage best practices manuals**, the development of which is also a DOE program goal [Goal 4].

# PROJECT OVERVIEW: GOALS AND OBJECTIVES

- Goal: To determine the feasibility of integrating commercial-scale capture of industrially sourced CO<sub>2</sub> emissions from NPPD's Gerald Gentleman Station (GGS) with subsequent storage at a proximate geologic site in western Nebraska safely, permanently, and certifiably.
- Objectives
  - Establish a CCS coordination team for the Nebraska effort. [*Goal 4*]
  - Develop a plan to address the challenges of a potential commercial-scale CCS project in western Nebraska. [*Goal 4*]
  - Conduct a high-level, technical subbasinal evaluation in western Nebraska and a CO<sub>2</sub> source assessment at GGS and other CO<sub>2</sub>-emitting facilities. [*Goals 1–4*]

# METHODOLOGY: ADVISORY BOARD FOR CCS

Nebraska Oil and Gas Con.



Nebraska Public Power District

*Always there when you need us*



UNIVERSITY OF  
**Nebraska**  
Lincoln

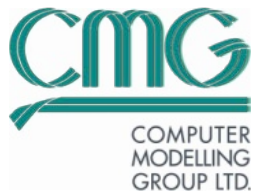

**BEREXCO**



# METHODOLOGY: CCS EXPERTISE

- Partnership for CO<sub>2</sub> Capture (PCO<sub>2</sub>C)
- 8-year program (2008–2016)

- Plains CO<sub>2</sub> Reduction (PCOR) Partnership
- +13-year program (2003–present)



# METHODOLOGY: OUTREACH

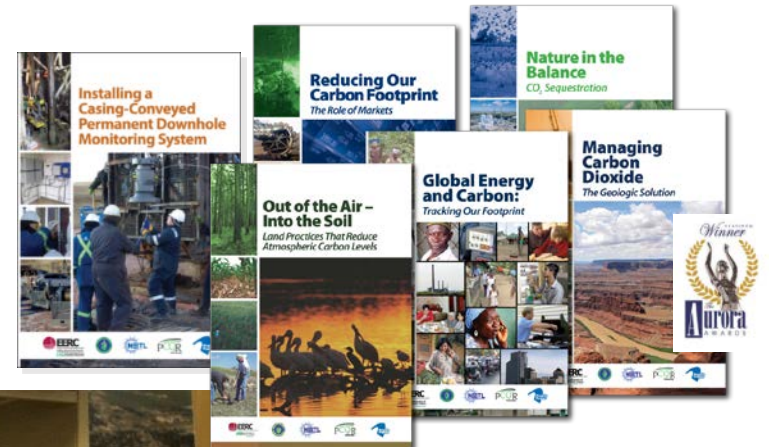

# METHODOLOGY: ESTABLISHED METHODS

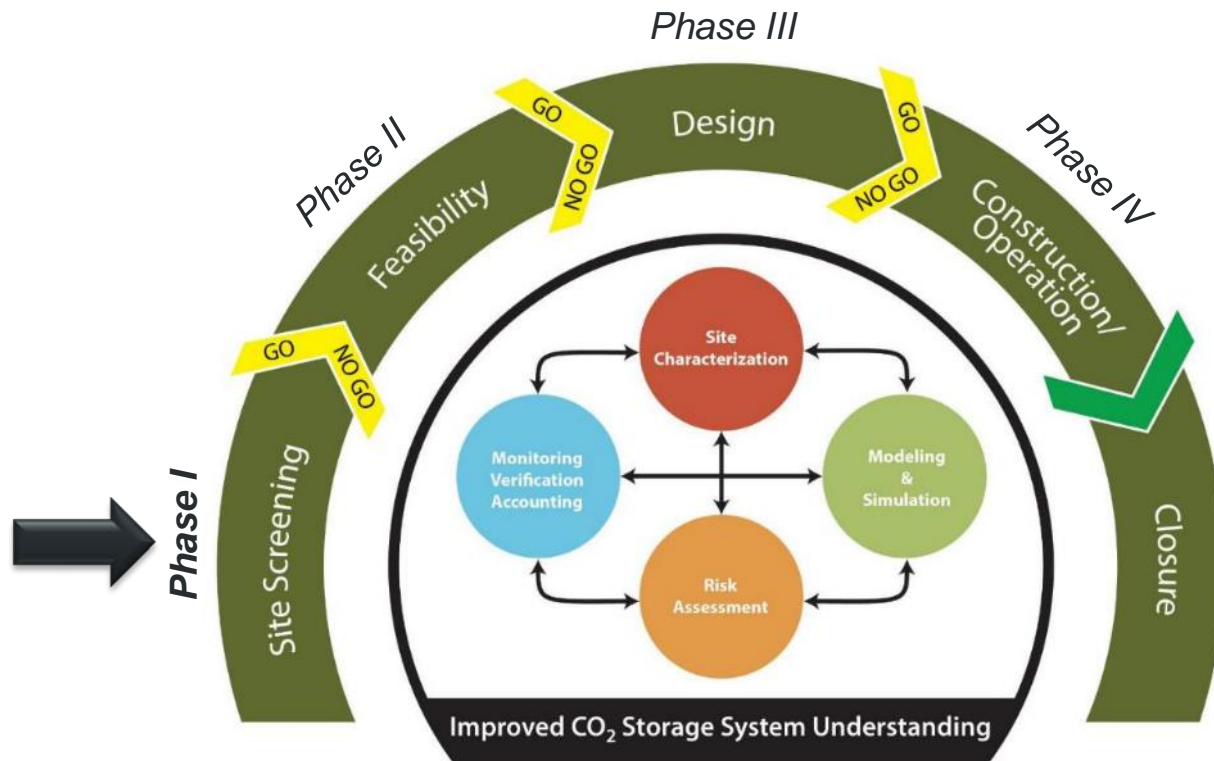

- The EERC has developed an adaptive approach to project management and execution.
  - Integrates multidisciplinary teams
  - Integrates data across project teams
- Technical methodologies developed and applied include the following:
  - Geologic modeling and reservoir simulation
  - Risk assessment
  - Monitoring, verification, and accounting (MVA)
  - Site characterization activities related to CCS
- Designed, drilled, and completed over one dozen wells for characterization and monitoring of CCS validation and demonstration projects.
- Shared lessons learned with industry and public.



# METHODOLOGY: BUILDING FROM EXISTING DATA

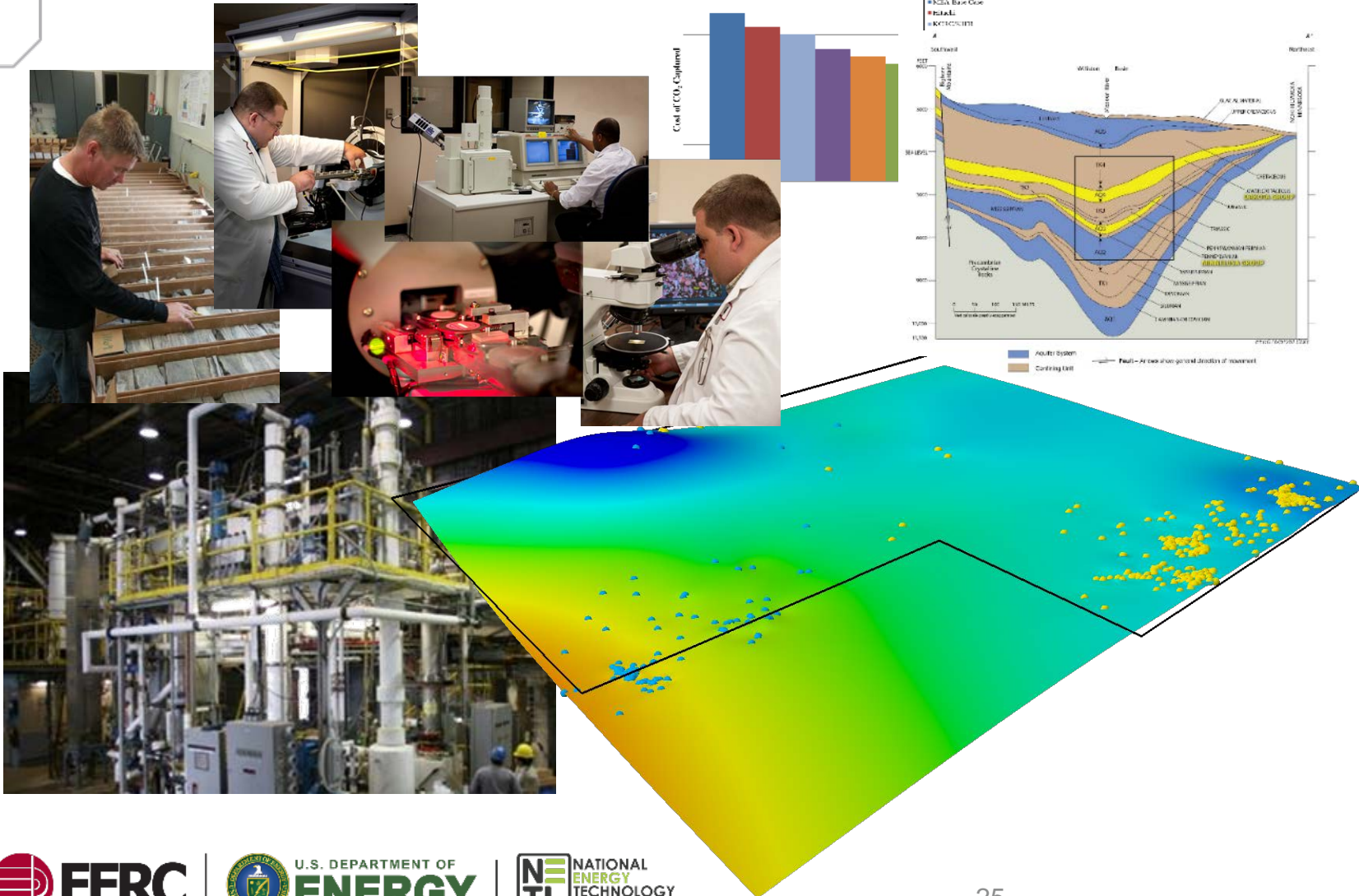

- The EERC has conducted many site characterization projects in the Great Plains for both private and public entities:
  - Carbon management plans
  - CO<sub>2</sub> injection studies
- The EERC has significant inventory of site characterization data and experience as a result of these activities.
- The EERC has direct experience with evaluating CO<sub>2</sub> capture technologies and understanding of challenges to implementation.

# EXPECTED OUTCOMES

- Sufficient information to move forward with a Phase II feasibility effort.
  - Final technical report
  - Journal article or technical paper draft
  - Generated data → NETL Energy Data eXchange (EDX)
- Establishment of a CCS coordination team for the Nebraska effort.
- Plans addressing potential challenges for CCS in western Nebraska.
  - Community outreach plan
  - Financial plan
- Completion of high-level, technical subbasinal and CO<sub>2</sub> source evaluations for the Nebraska effort.
  - Future characterization plan

# TASK AND SUBTASK BREAKDOWN

- Task 1.0 – Project Management, Planning, and Reporting
- Task 2.0 – Regional and Stakeholder Analysis
- Task 3.0 – Scenario Analysis
- Task 4.0 – Subbasinal Analysis
- Task 5.0 – NRAP Validation

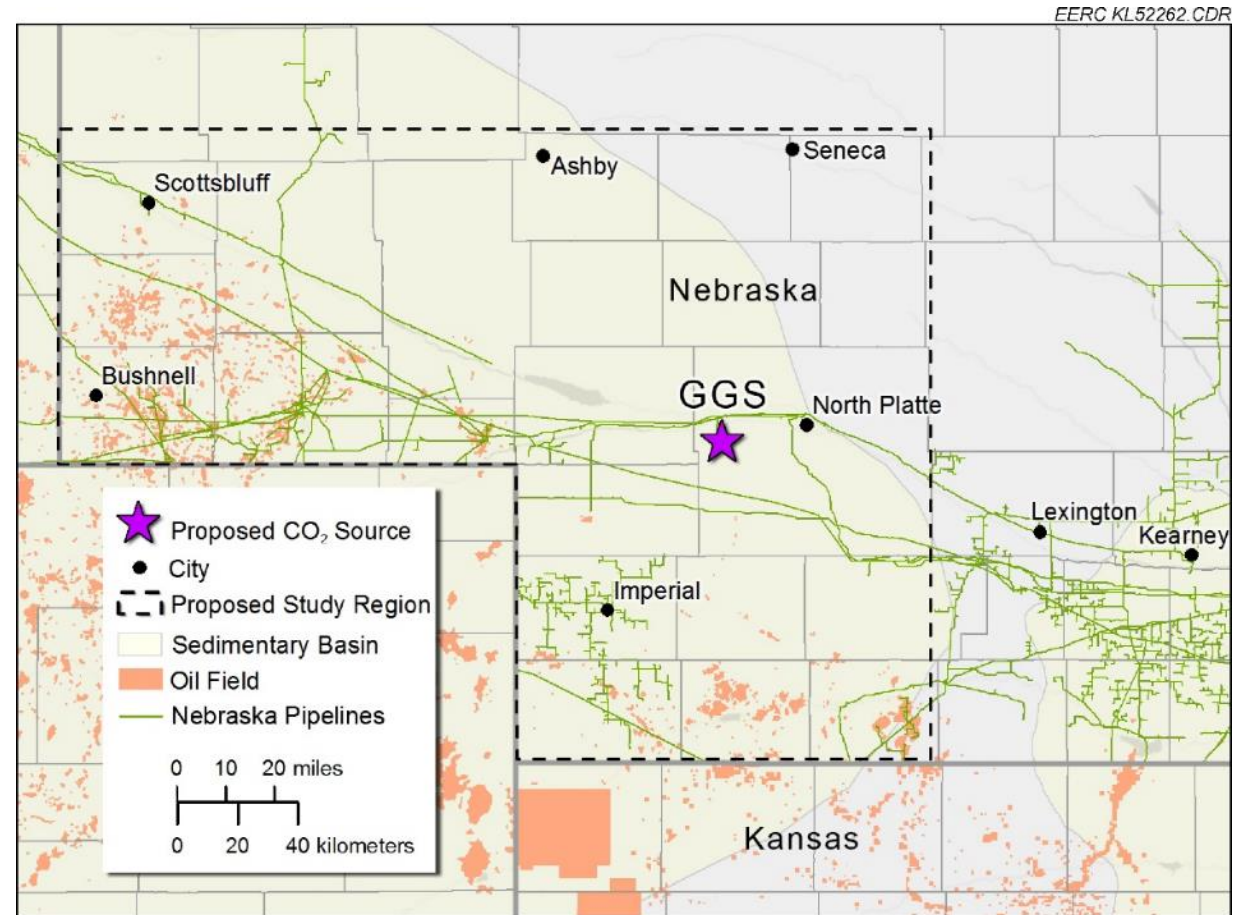

# ORGANIZATION CHART/COMMUNICATION PLAN

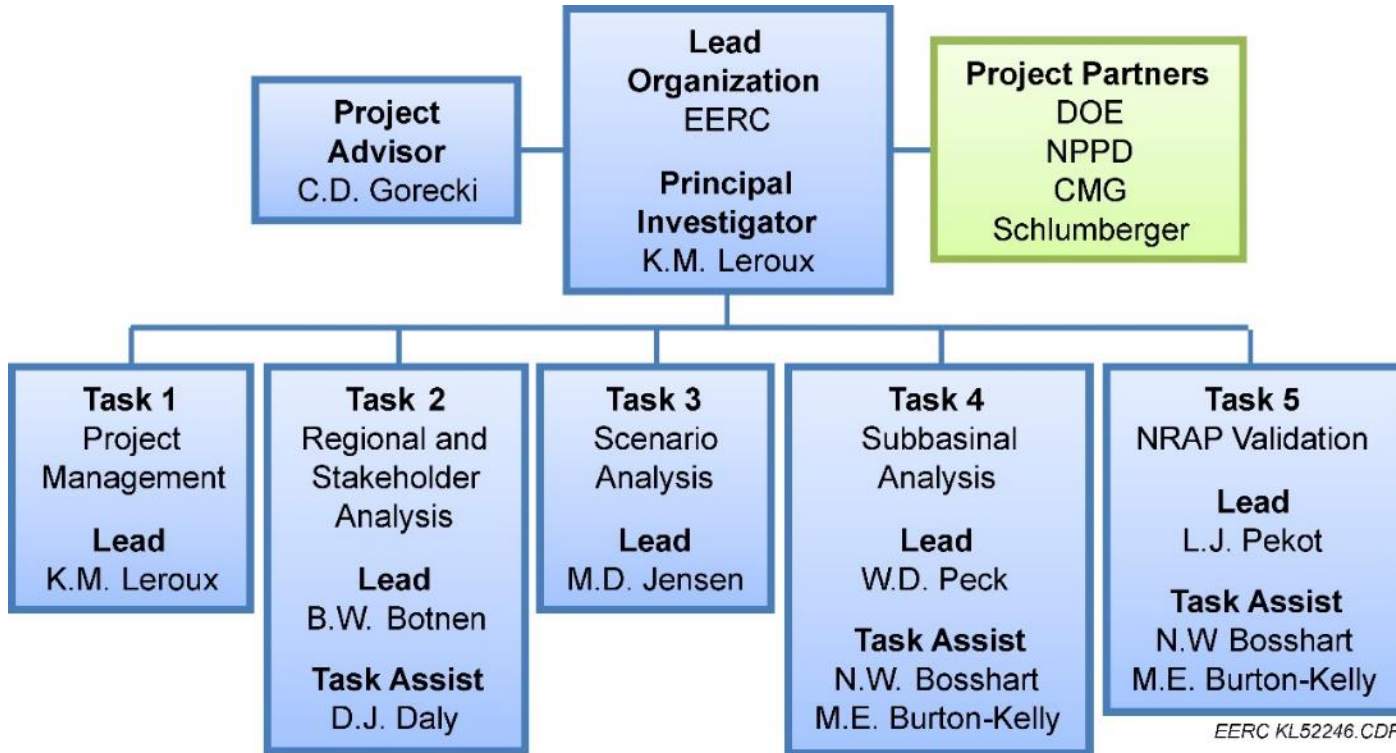

- Regular update meetings with project team.
- Communication with partners/consultants via conference call, e-mail, Webinar, and in-person meetings.
- Quarterly reports and annual briefings to DOE.
- Major decisions affecting scope, budget, or time line will be discussed with the DOE project manager.

# PROPOSED SCHEDULE

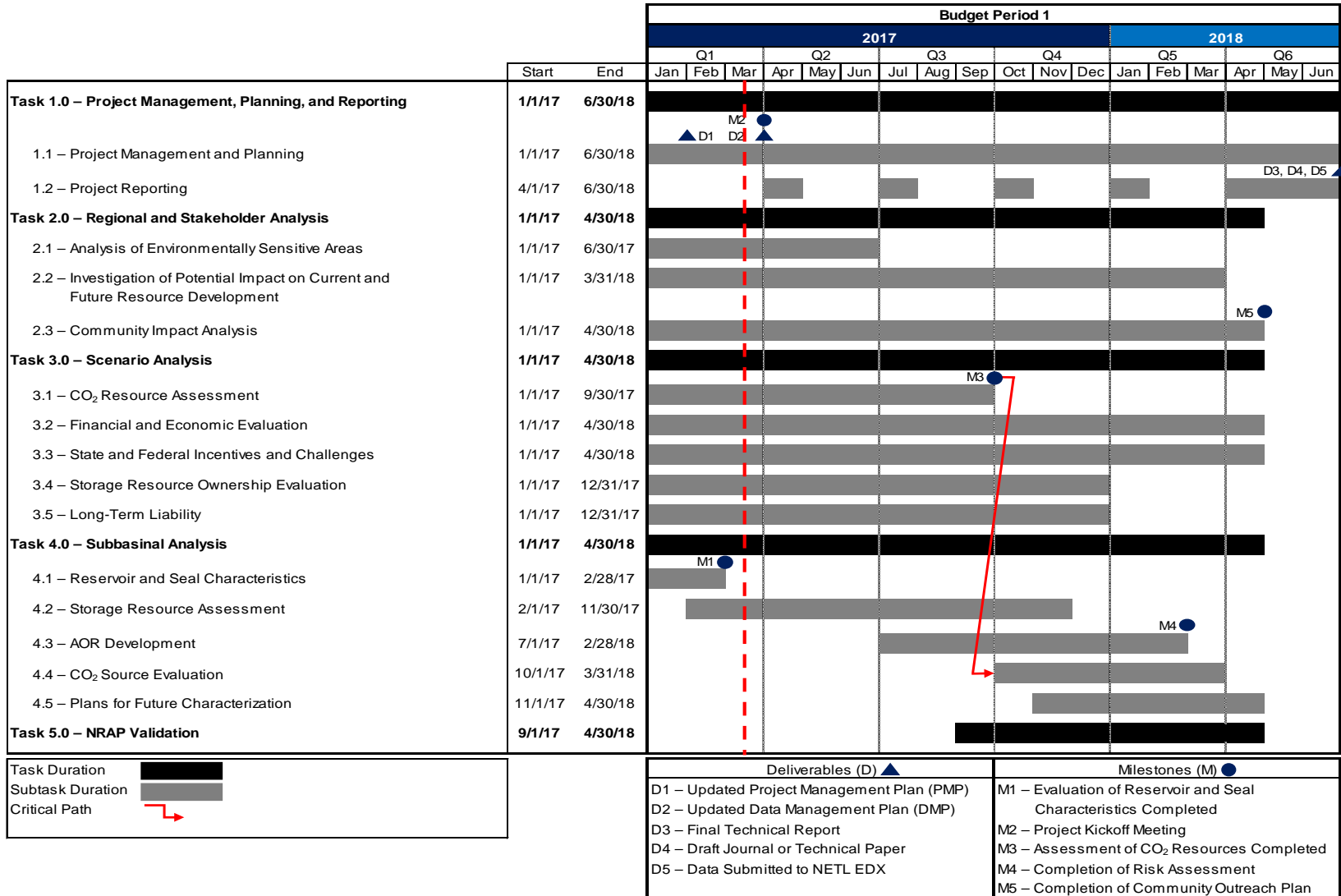

# DELIVERABLES, MILESTONES, AND DECISION POINTS

## Deliverables/Reports

ID	Title/Description	Planned Completion Date
D1	Project Management Plan	Updated as necessary/ requested
D2	Data Management Plan	Updated as necessary/ requested
D3	Final Technical Report	6/30/18
D4	Journal Article or Technical Paper Draft	6/30/18
D5	Data Submitted to NETL EDX	6/30/18

## Milestones

Title/Description	Related Subtask	Planned Completion Date	Verification Method
*M1 – Evaluation of Reservoir and Seal Characteristics Completed	4.1 – Reservoir and Seal Characteristics	2/28/17	Reported in subsequent quarterly report
M2 – Project Kickoff Meeting Held	1.1 – Project Management and Planning	3/31/17	Presentation file submitted to DOE
*M3 – Assessment of CO <sub>2</sub> Resources Completed	3.1 – CO <sub>2</sub> Resource Assessment	9/30/17	Reported in subsequent quarterly report
M4 – Completion of Risk Assessment	4.3 – AOR Development	2/28/18	Reported in subsequent quarterly report
M5 – Completion of Community Outreach Plan	2.3 – Community Impact Analysis	4/30/18	Reported in subsequent quarterly report

\*Decision points

# SUCCESS CRITERIA

- Subtask 4.1 – Reservoir and Seal Characteristics. A list of potential saline formations in western Nebraska will be generated and ranked on applicability for commercial-scale CO<sub>2</sub> storage (M1), allowing for initiation of Subtask 4.2 – Storage Resource Assessment.
- Subtask 3.1 – CO<sub>2</sub> Resource Assessment. An investigation of industrial CO<sub>2</sub> sources in western Nebraska will be conducted (M3), allowing for initiation of Subtask 4.4 – CO<sub>2</sub> Source Evaluation.
- Subtask 4.3 – Area of Review (AOR) Development. A risk assessment will be conducted to identify potential constraints with candidate reservoirs serving as commercial storage sites and provide a mitigation plan (M4).
- Subtask 2.3 – Community Impact Analysis. A community outreach plan will be developed to educate/inform the public, leaders, and decision makers, incorporating methods to evaluate public perception of CCS and to mitigate any potential conflicts (M5).
- A final technical report (D3) will be prepared and submitted.

# RISK MATRIX

Category	Potential Risk	Mitigation
Technical Difficulties	Insufficient data or loss of data	<ul style="list-style-type: none"> <li>• Large in-house geological database. Large amount of public data easily available.</li> <li>• Workstations and servers backed up.</li> </ul>
	Issues with reservoir-modeling and simulation software	<ul style="list-style-type: none"> <li>• Extensive expertise and familiarity.</li> <li>• Working history with vendors and support services.</li> </ul>
Resource Availability	Insufficient computing capability	<ul style="list-style-type: none"> <li>• Multiple existing computer stations.</li> <li>• High-performance computing cluster.</li> </ul>
	Lack of personnel	<ul style="list-style-type: none"> <li>• Cross-training and redundancy in skill sets.</li> <li>• Senior management overseeing personnel and resource availability.</li> </ul>
Environmental, Health, and Safety (EHS)	Personal injury	<ul style="list-style-type: none"> <li>• No fieldwork component in this Phase 1 effort.</li> </ul>
	Environmental impact	<ul style="list-style-type: none"> <li>• Scope of work includes only analysis and interpretation of the collected data.</li> </ul>
Management Issues	Inability to manage large-scale project	<ul style="list-style-type: none"> <li>• Majority of work conducted at the EERC facility, allowing regular interaction and communication with project team members.</li> <li>• Planning meetings held before fieldwork.</li> <li>• Proven working relationship with consultants and project partner.</li> <li>• Existing standardized workflow processes, communication protocols, and contractual procedures.</li> <li>• Working knowledge of managing similar-scale resource assessment and oil- and gas-related projects.</li> </ul>



# APPENDIX: FUNDING TABLES

## Baseline Project Cost by Task

Task No.	Cost, \$
1.0	167,538
2.0	367,864
3.0	242,755
4.0	955,734
5.0	51,993
<b>Total</b>	<b>1,785,884</b>

## Funding Profile by Recipient Organization

	BP1	
Recipient Organization	DOE, \$	Nonfederal Cost Share, \$
<b>EERC</b>	1,244,473	541,411

## Funding Profile by Cost-Sharing Partner

Funding Source	Type	BP1, \$
<b>DOE</b>	Cash	1,244,473
<b>NPPD*</b>	Cash	47,031
<b>NPPD</b>	In-kind	25,000
<b>CMG, Ltd.</b>	In-kind	169,380
<b>Schlumberger</b>	In-kind	300,000
<b>Total</b>		<b>1,785,884</b>

\*NPPD will provide \$50,000 of cash cost share as indicated in its letter of commitment. However, only \$47,031 can be recognized by DOE as cost share because of a differential in the F&A rate applied to nonfederal sponsors.



**EERC**<sup>SM</sup>

Critical Challenges.

**Practical Solutions.**