

Greenhouse Gas Emissions Reduction and Development Leading to Cost-Competitive CTL Based Jet Fuel Production



CERAMATEC[®]

TOMORROW'S CERAMIC SYSTEMS

**2015 Gasification Systems and
Coal-Biomass to Liquids Workshop**
August 10-11, 2015 Morgantown, WV

**J. Hartvigsen, L. Frost, S. Elangovan, J. Elwell
P. Dimick (IntraMicron)
NETL Award DE-FE0023863, PM John Rockey**

CBTL Process-Program Connectivity

System Demonstration Scope

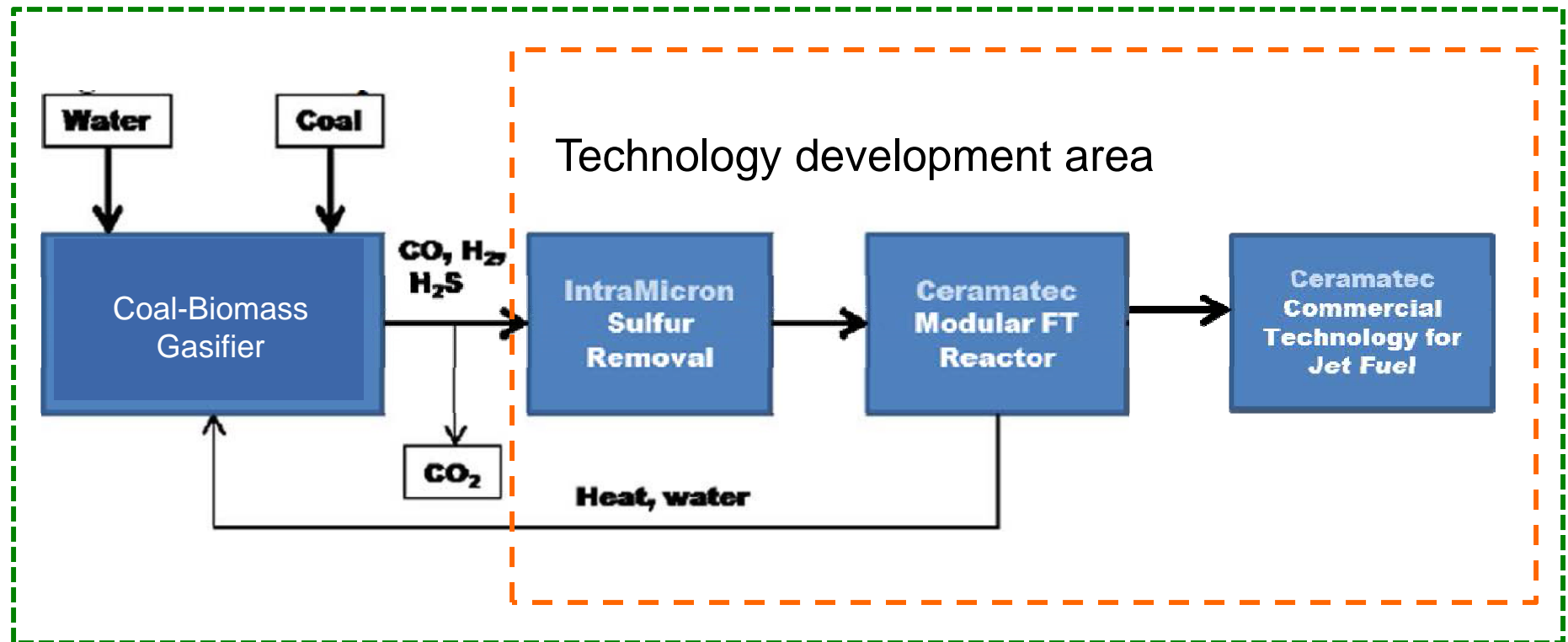

Ceramatec FT System Strategy



- Scale, Scope & Cost
 - Small 0.1% to 10% of “World Scale” GTL
 - Product syncrude with minimal upgrading
 - CAPEX << \$100k/bbl/day
- Shop fabrication
 - Reduce cost versus site built plants
 - Transportability to site (size limits on road transport)
 - Quality control and mass production vs. traditional economies of scale
- Catalyst loading and transport
 - Catalyst servicing done in shop
 - Replaceable reactor elements
 - Catalyst reduced and ready to operate
- Minimum infrastructure required
- Take advantage of a variety of small distributed resources
 - Biomass, biogas, coal-biomass blend
 - Stranded gas, associated gas
 - CO₂ co-electrolysis as intermittent renewable energy storage

Project Goals and Objectives



1. Produce products that include a commercially-viable quantity of jet fuel (e.g., Jet-A or JP-8 MIL-DTL-83133);
 4. A “commercially-viable quantity” would be the minimum amount of fuel on a regular basis that would be purchased at a cost-competitive price by either the Defense Logistics Agency (DLA Energy) or a commercial aviation fuel-buying agency. For the purposes of this FOA, Applicants should have in mind target plants that would be able to deliver a minimum of thousands of gallons of jet fuel per single customer purchase.
- **The Ceramatec lead team is proceeding with demonstration of nominal 2 bbl/day FT pilot plant, producing a nominal 1 bbl/day in the Jet-A/JP-8 fraction. This will produce over 1,000 gallons of jet fuel per month, and be the basis of a 100 bbl/day module producing over 2,000 gallons of jet fuel per day.**

Project Goals and Objectives



2. Make significant progress toward compliance with Section 526 of the Energy Independence and Security Act of 2007 (EISA 2007 § 526) lifecycle greenhouse gas (GHG) emissions requirements; and,

Sec. 526. Procurement and Acquisition of Alternatives Fuels

- Prohibits agencies from entering into contracts for procurement of alternative or synthetic fuel, including fuel from non-conventional petroleum sources, for any mobility-related use, other than research or testing. An exception is made if the contract specifies that lifecycle greenhouse gas emissions associated with the production and combustion of fuel supplied under the contract must, on an ongoing basis, be less than or equal to emissions from equivalent conventional fuel produced from conventional petroleum sources.
- **Co-gasification of coal-biomass blends enable a reduction of lifecycle greenhouse gas emissions from equivalent conventional petroleum derived fuel basis. Implementation of a significant biomass feed stream will require smaller plants than current world scale CTL/BTL. Hence a down-scaleable design is essential.**

Project Goals and Objectives



3. Make significant progress toward being cost-competitive with conventional petroleum-based jet fuel.
- **Due to the reduced part count and complexity of Ceramatec's 4" modular reactor design, fabrication and maintenance (catalyst service) cost are significantly reduced compared to conventional small tube fixed-bed FT reactors, or the advanced micro-channel reactors.**
 - **A simplified process flow-sheet made possible by advanced, wax free catalyst requires only modest upgrading or refining to produce a significant jet fuel fraction. Elimination of the wax hydrocracker and hydrogen plant is a major simplification and cost savings in construction and operation.**
 - **A mass-produced, modular, road transportable plant design can achieve world scale economies of scale in small plants that can be sized and reconfigured to match the biomass resource.**

Small FT with Large Reactor Tubes?

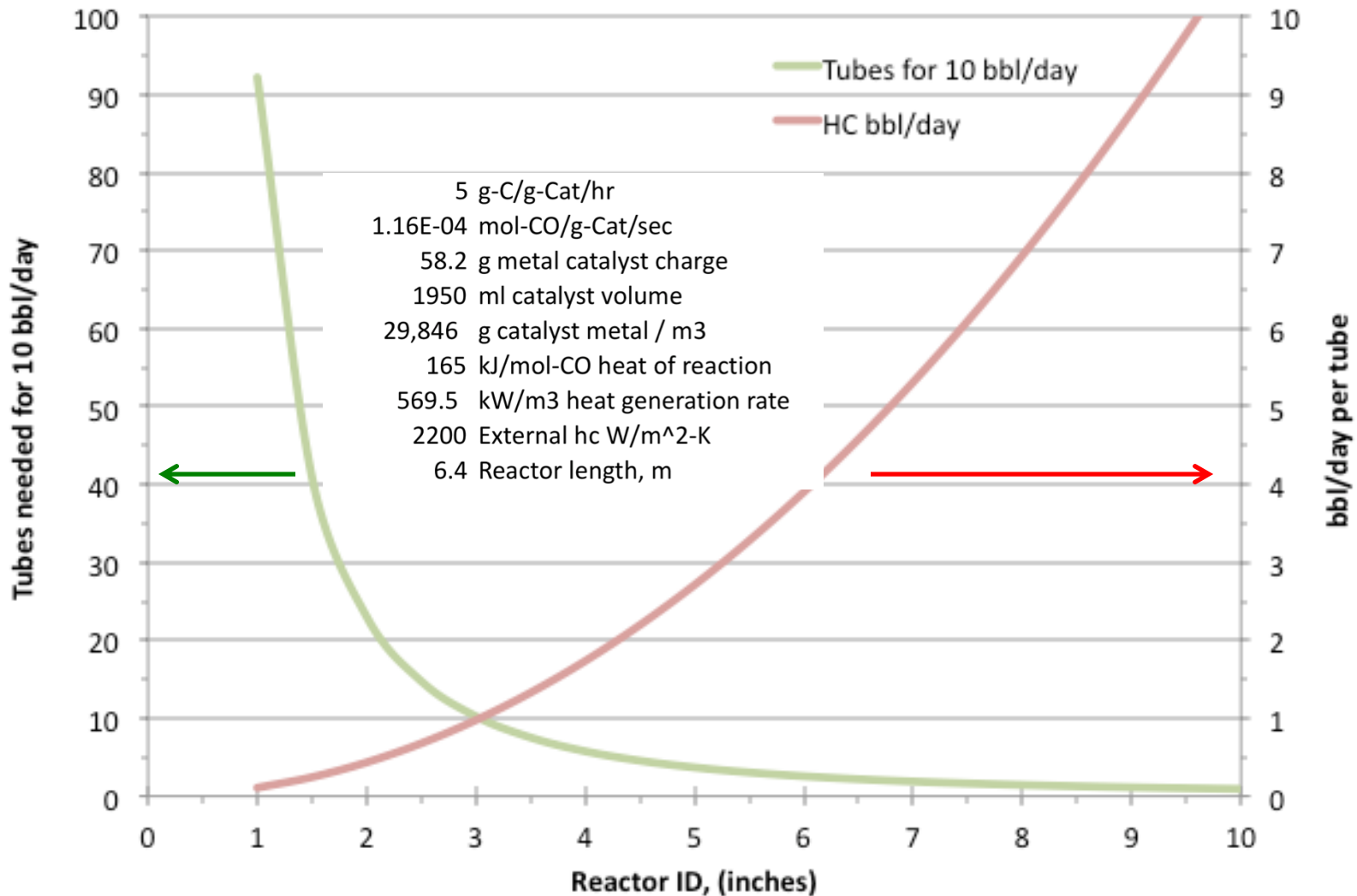

MFEC Reactor Temperature Profile

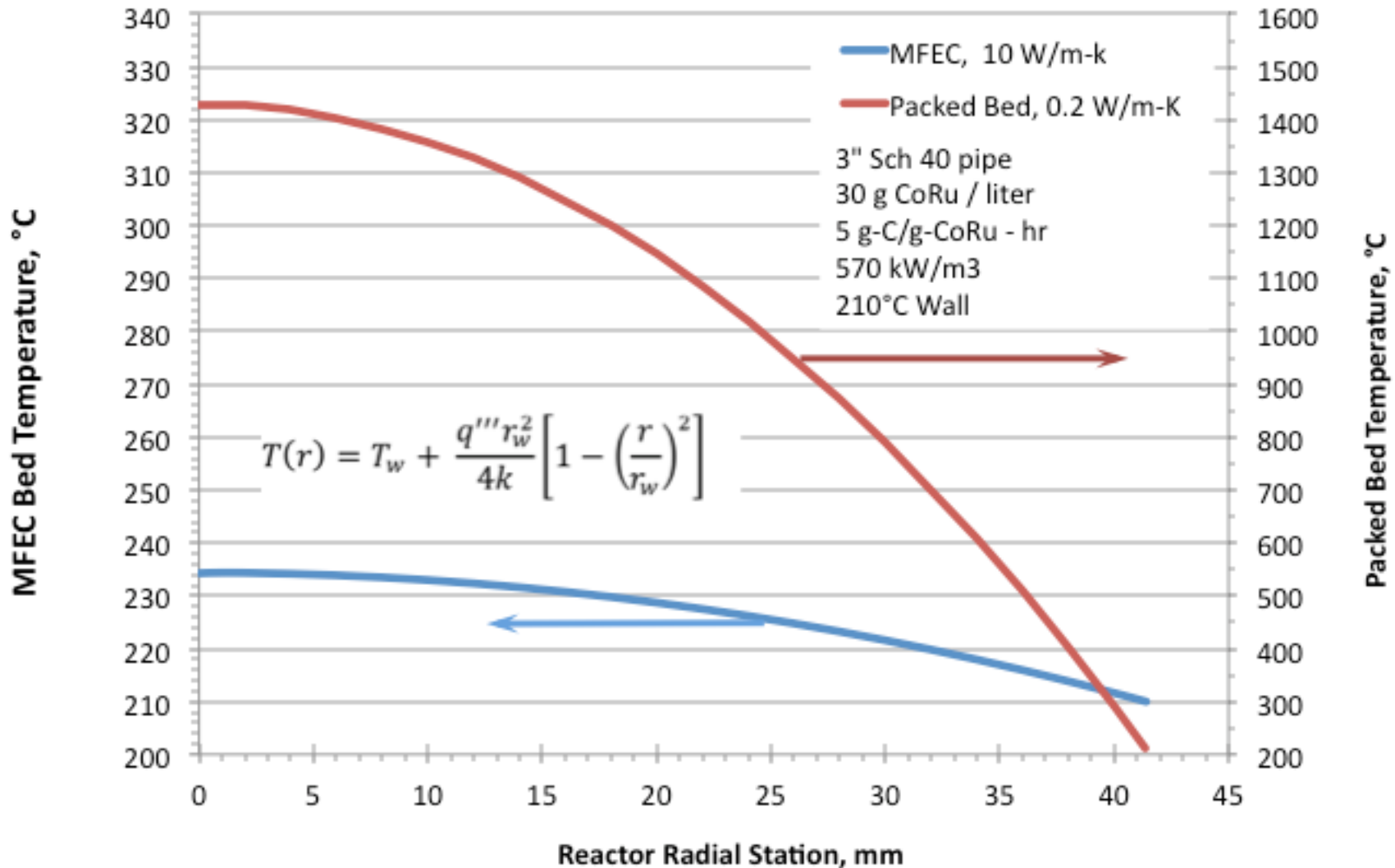



Microfibrinous Entrapped Catalysts (MFECs)



MFECs simultaneously enhance heat and mass transport to enable near-isothermal operation of large-diameter reactors allowing process intensification of highly enthalpic reactive systems.

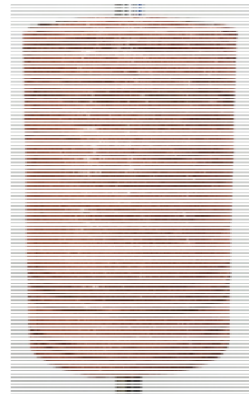
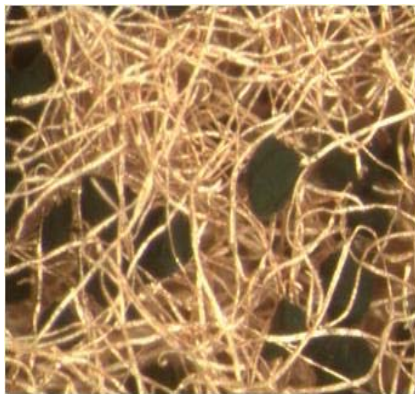

Microfibrinous Entrapped Catalyst

Small catalyst particles entrapped in a sinter-locked network of conductive metal fibers

Benefits:

1. Enhanced selectivity
2. High volumetric productivity
3. Improved catalyst utilization
4. Improved activity maintenance
5. Minimizes impact of thermal upsets
6. Accepts any pre-manufactured catalyst

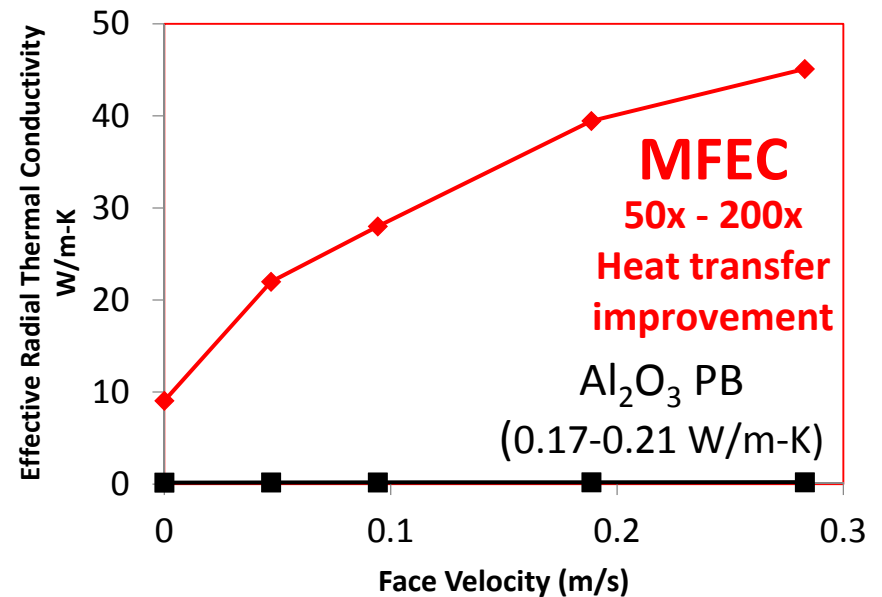

MFECs provide benefits that increase robustness and reduce CAPEX and OPEX to facilitate process intensification using simple, high-performance modular reactors

Alternative Thermal Structure

- Geometric optimization FE thermal model

- Higher average temperature

- ↑ Production and thermal risk

- Lower average temperature

- ↓ Production and thermal risk

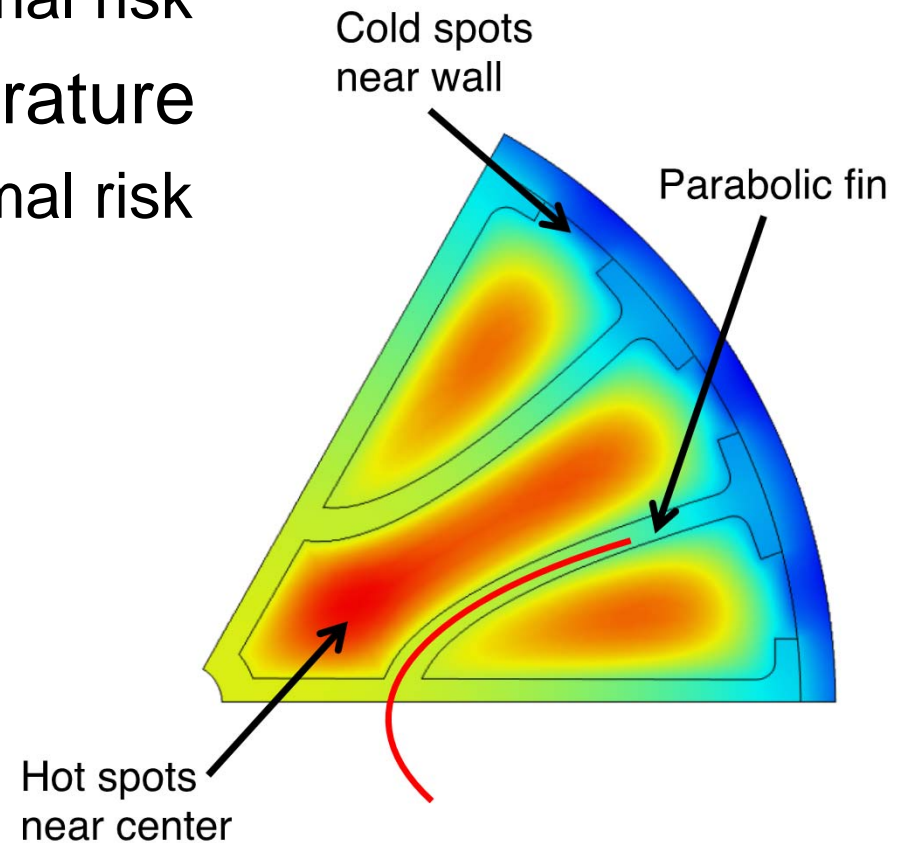
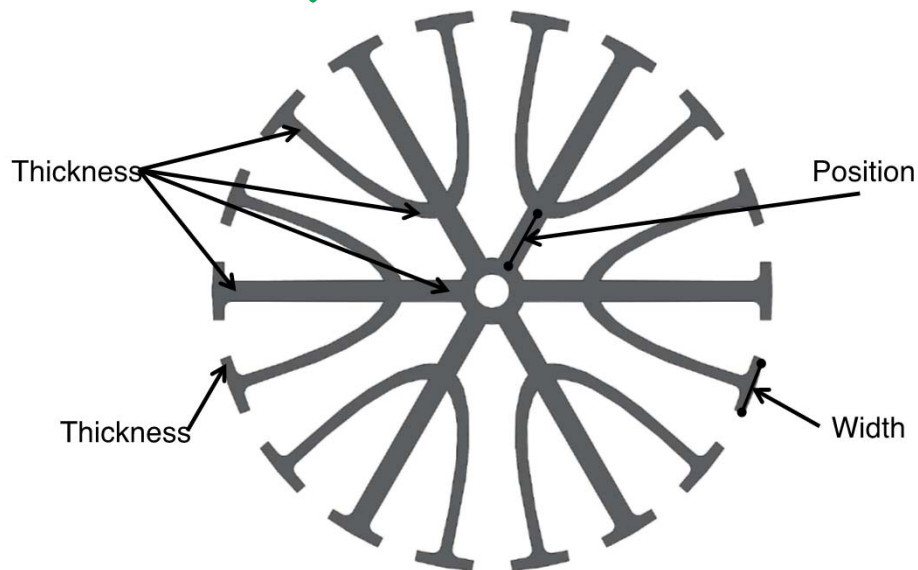

Aluminum extrusion reactor insert for thermal management



IntraMicron Desulfurization Technology Suite (IM-DTS)



IntraMicron's Scalable Desulfurization Technology Suite is a synergistic combination of an oxidative sulfur removal (OSR) Catalyst, a desulfurization sorbent (regenerable or disposable), and a bed life sensor that enables efficient sulfur removal from distributed energy resources.

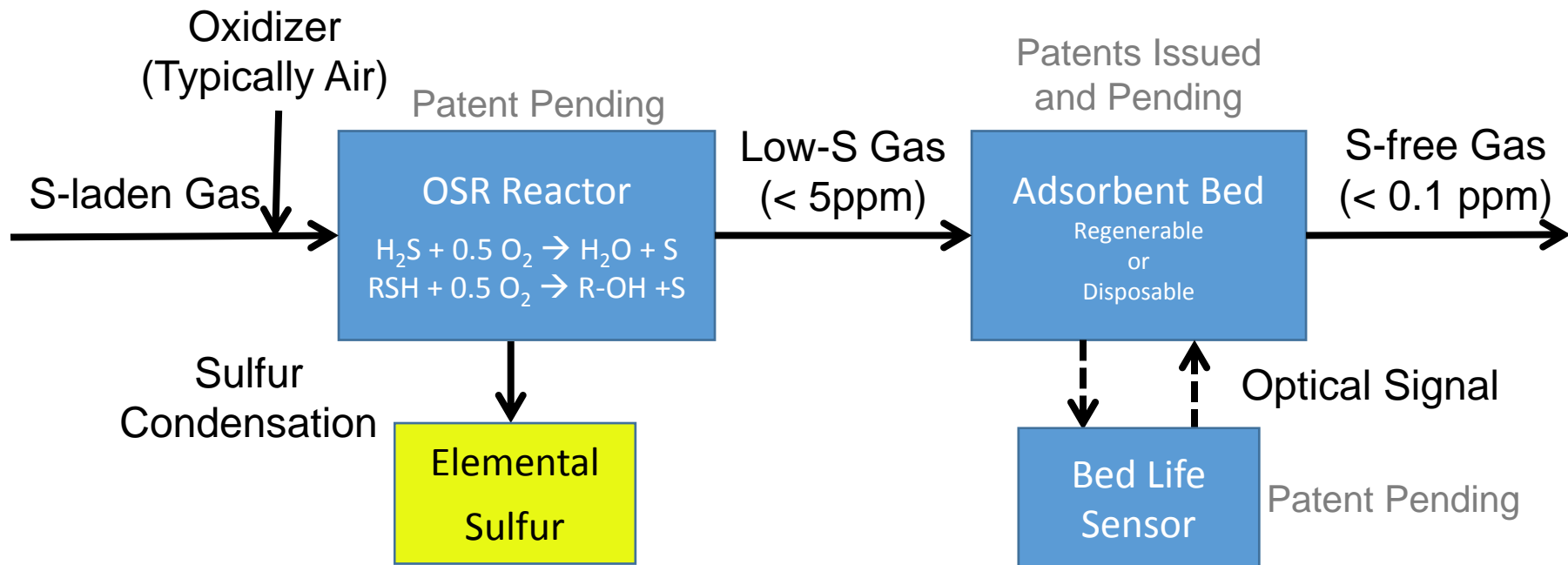

- OSR converts majority of H_2S to elemental sulfur without significant SO_2 production
- BLS optimizes adsorbent utilization to minimize waste
- Process easily accommodates varying sulfur levels and outlet thresholds
- Up to 75% cost reduction compared to current state of the art technologies

Ceramatec 4" FT Pre-Pilot Facility

- Plasma reformer
- Syngas compression
- Syngas drying
- Syngas storage
- Modular reactor
- 4" dia advanced FT cooling structures

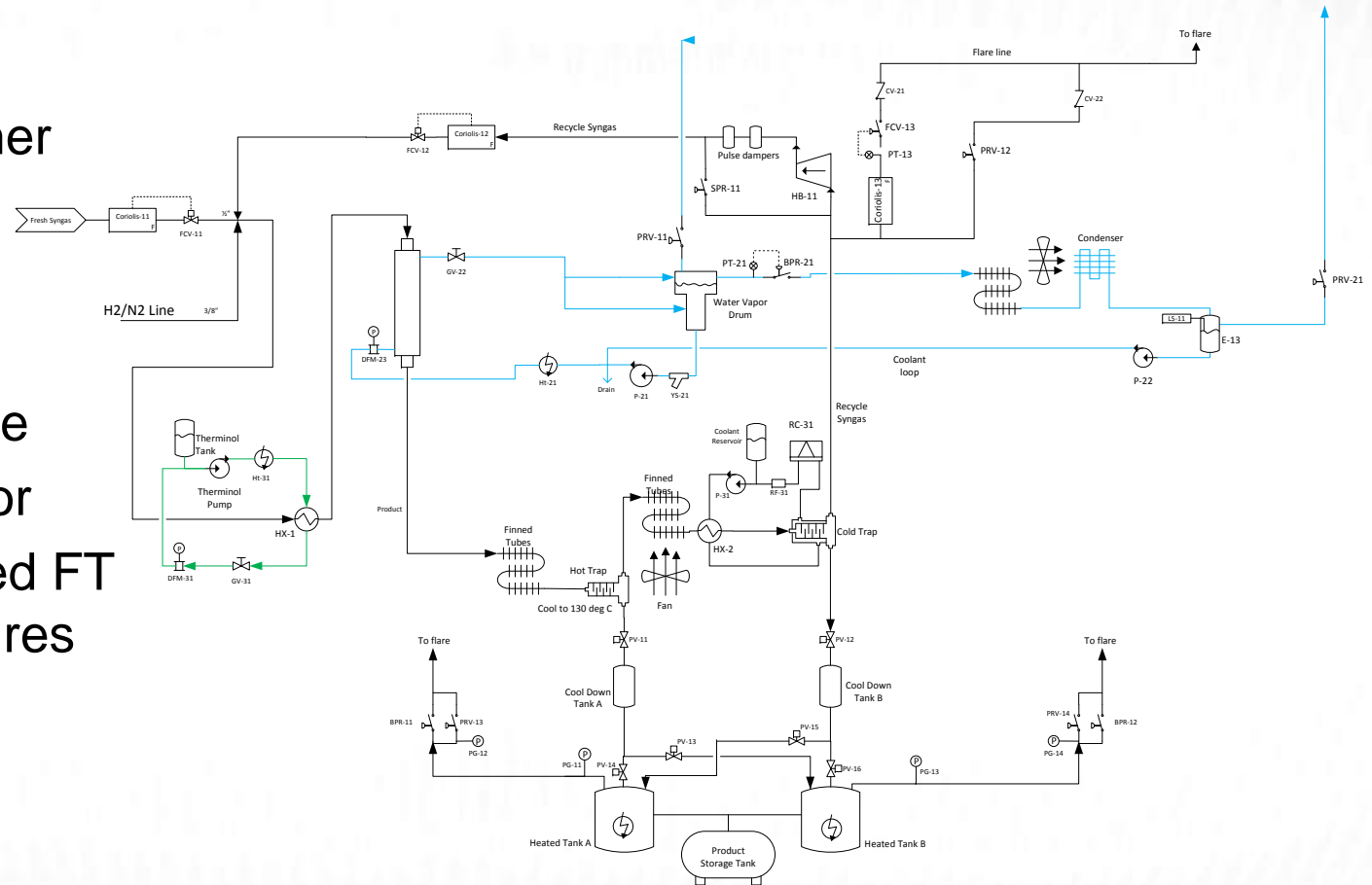

CERAMATEC
TOMORROW'S CERAMIC SYSTEMS

Ceramatec Plasma Reformer



- Nominal 10 psi operation
- Capacity for 2 BPD pre-pilot plant
- Demonstrating
 - 80kW 100 psi steam generator
 - Industrial pneumatic control valves
 - 3" 15 psi, 120 MMCFD gas line



Syngas Compressor for 2 bbl/day Commissioning



CERAMATEC
TOMORROW'S CERAMIC SYSTEMS

Ceramatec Syngas Storage Facility

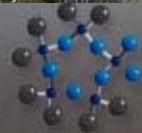

CERAMATEC
TOMORROW'S CERAMIC SYSTEMS

Single 4" Tube FT Reactor Test System



CERAMATEC
TOMORROW'S CERAMIC SYSTEMS

FT Product Collection



Wax Free Product Hybrid Co Trilobe-Fin



CERAMATEC
TOMORROW'S CERAMIC SYSTEMS

Wax Free Product Hybrid Co in MFEC

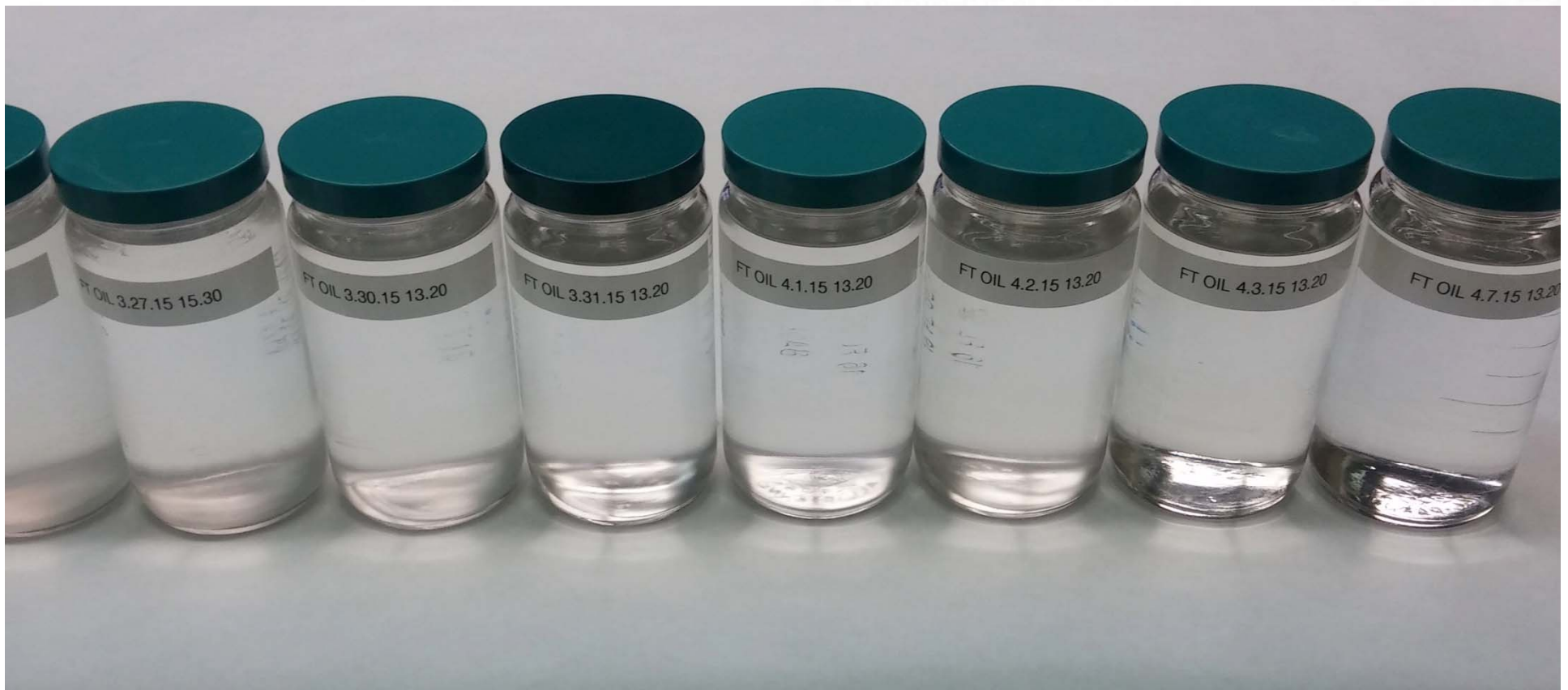

CERAMATEC
TOMORROW'S CERAMIC SYSTEMS

Hybrid Co in MFEC Product Distribution

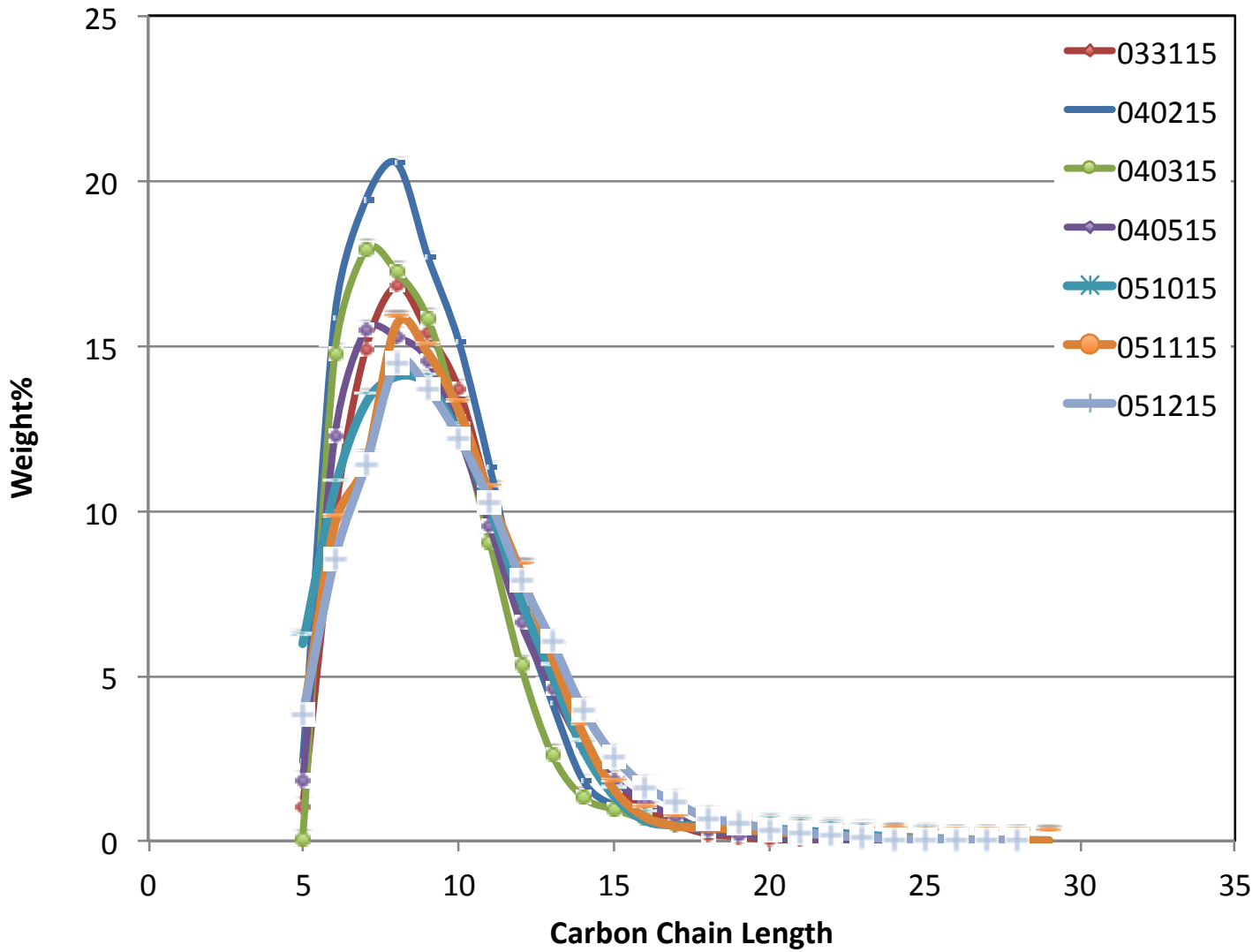

Ceramatec 4" FT Runs Q1-Q2 2015

- FT operations March 19 to June 01
 - 74 Calendar Days
 - 54 Operating Days (nominal 1296 hours)
 - 2 catalyst regeneration cycles
- Product collection
 - 45 sample collection periods
 - 375 kg (136 gal) FT oil collected and stored
 - Carbon number distribution by SimDis GC
 - 920 kg FT produced water
 - Treated, tested, discharged
- Production rate
 - Varying syngas composition, pressure, reactor temperature
 - 2.53 gal/day average including startup
 - 3.88 gal/day sustained over 12 day period
 - 5.1 gal/day peak rate



CERAMATEC
TOMORROW'S CERAMIC SYSTEMS

Selectivity & Productivity Extrudate-Fin

- 23 Dec 2014
 - 1.25 kg hybrid Co trilobe
 - 240° C reactor
 - 20 bar exit
 - 3.22 SCFM syngas
 - 35% N₂, 40% H₂, 19% CO
 - 8 SCFM recycle
 - 92% H₂ conversion
 - 86% CO conversion
 - 23.3% CH₄ selectivity
 - 3.4% CO₂ selectivity
 - 0.197 gC5+/g-cat/hr
- 16 Oct 2014
 - 1.25 kg hybrid Co trilobe
 - 250° C reactor
 - 20 bar exit
 - 4.59 SCFM syngas
 - 52% N₂, 29% H₂, 14% CO
 - 10 SCFM recycle
 - 79% H₂ conversion
 - 71% CO conversion
 - 32.5% CH₄ selectivity
 - 2.6% CO₂ selectivity
 - 0.091 gC5+/g-cat/hr



Selectivity & Productivity MFEC

- 05 April 2015

- 2kg hybrid Co in MFEC
- 240° C reactor
- 20 bar exit
- 5.88 SCFM syngas
 - 26% N₂, 45% H₂, 22% CO
- 10 SCFM recycle
- 78% H₂ conversion
- 78% CO conversion
- 18.8% CH₄ selectivity
- 0% CO₂ selectivity
- 0.359 gC5+/g-cat/hr

- 12 May 2015

- 2kg hybrid Co in MFEC
- 220° C reactor
- 20 bar exit
- 4.64 SCFM syngas
 - 23% N₂, 48% H₂, 24% CO
- 8 SCFM recycle
- 52% H₂ conversion
- 51% CO conversion
- 15.3% CH₄ selectivity
- 0% CO₂ selectivity
- 0.185 gC5+/g-cat/hr



2 bbl/day FT Reactor in Fabrication

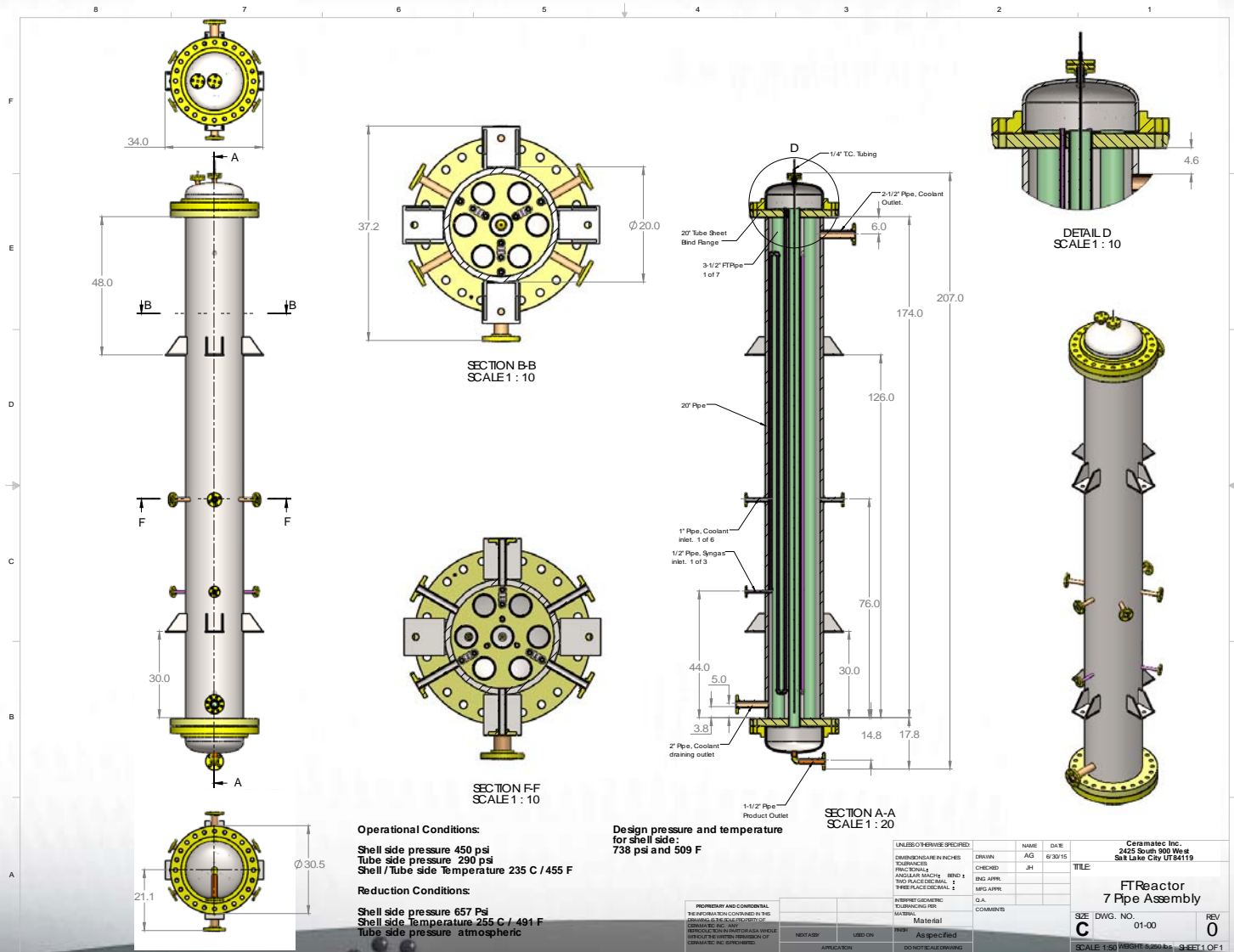

Ceramatec 10 bbl/day Pilot Plant Designed & Priced

- Three skids plus container and air compressor
 - Skid 1: 12' x 12' x 36'
 - Skid 2: 12' x 12' x 32'
 - Skid 3: 12' x 12' x 24'

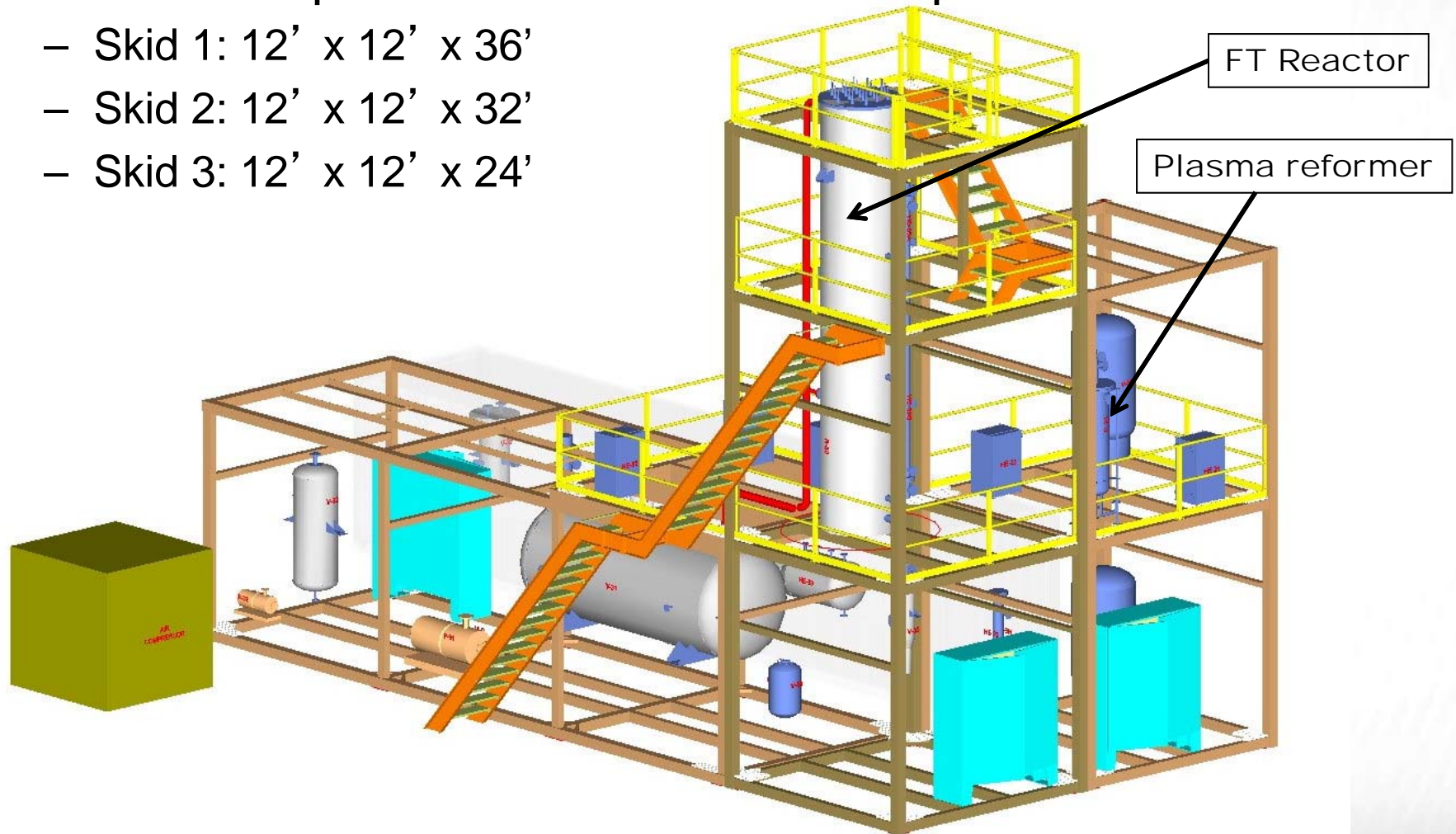

100bbl/day FT Module Concept

Removable multi-tube module

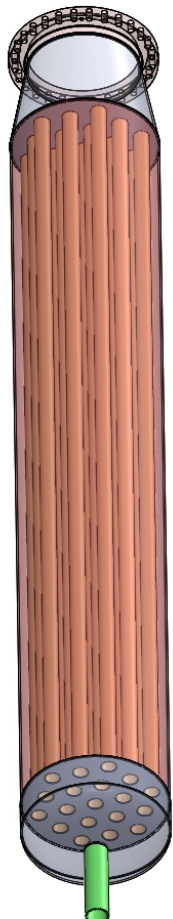

Catalyst change access to 19 tube
10-20 bbl/day removable element

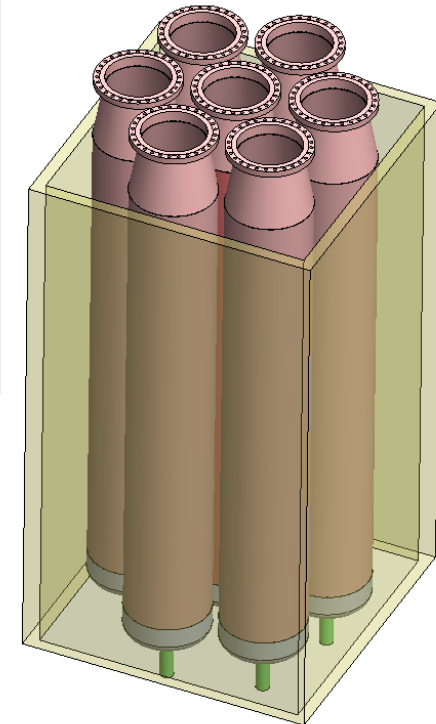
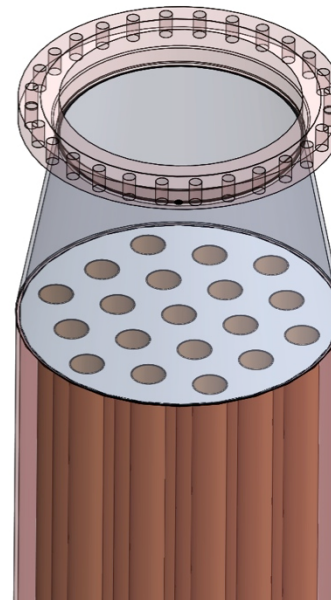
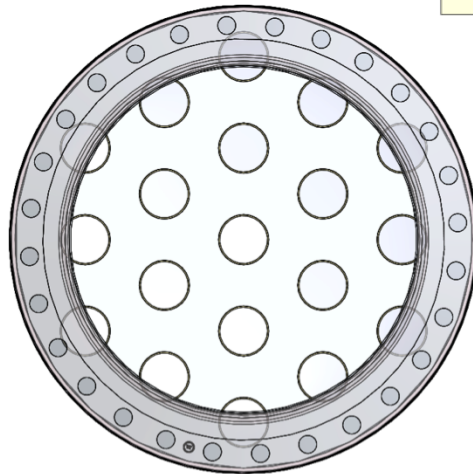
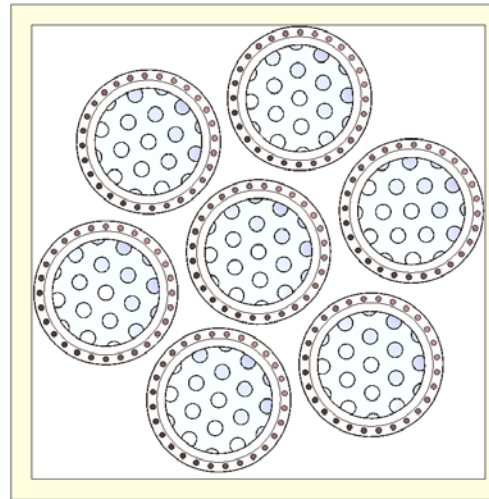

Road transportable
~100 bbl/day module
in 12' x 12' x 24' frame

Commercialization Prospects

- Ceramatec 4" FT reactor demonstrated
- Next step, 4" multi-tube reactor
 - Initial testing on plasma reformed natural gas
 - Coal gas testing with gasifier partner
- Multiple parties showing interest > 100 bbl/d
- Early adopters likely GTL/BTL
 - GTL, variety of niche applications
 - BTL, variety of feed stocks



CERAMATEC[®]
TOMORROW'S CERAMIC SYSTEMS

Energy Storage Via Electrolytic Synfuel



**Advanced
Concentrator PV**

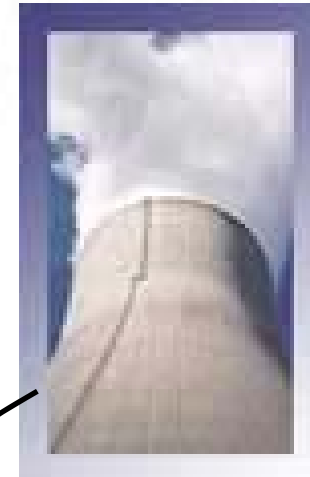

Gen IV Nuclear



Wind

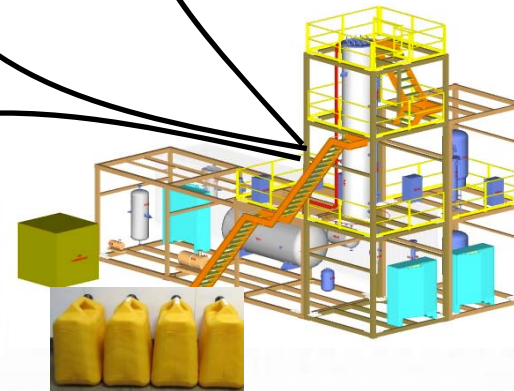

CO₂ Electrolysis to FT Synfuels

