

Rapid-Temperature Swing Adsorption Using Polymeric/Supported Amine Hollow Fiber Materials

Georgia Institute of Technology

DOE Award #: DE-FE0007804

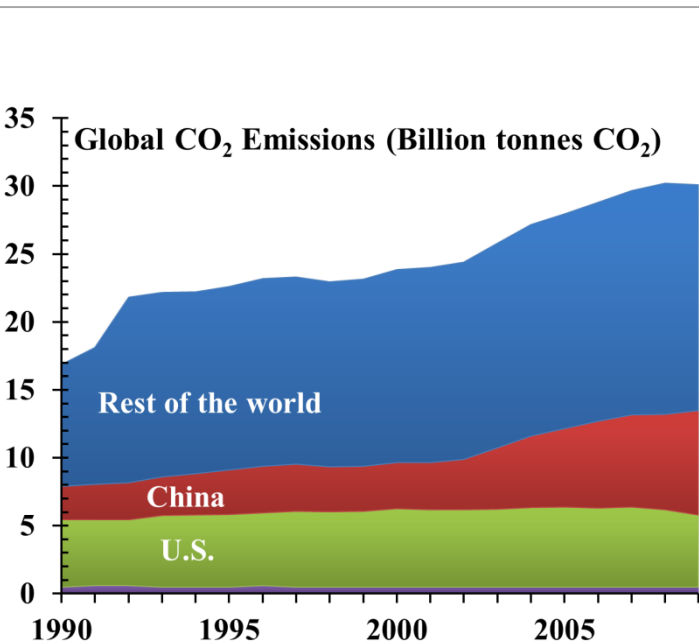

International Energy Outlook 2013,
US Energy Information
Administration 2013, DOE/EIA-0484

Acknowledgements and Funding

Ms. Grace Chen
Dr. Yanfang Fan
Prof. Christopher W. Jones
Ms. Jayashree Kalyanaraman
Prof. Yoshiaki Kawajiri
Prof. William J. Koros
Dr. Ying Labreche
Prof. Ryan Lively
Prof. Matthew Realff
Dr. Fateme Rezaei
Ms. Katherine Searcy
Prof. David S. Sholl
Dr. Subramanian Swernath
Dr. Simon Pang

SOUTHERN
COMPANY



ALGENOL
BIOFUELS
Harnessing the sun to fuel the world

Key Idea:

Combine:

(i) state-of-the-art supported amine adsorbents, with

(ii) a new contactor tuned to address specific weaknesses of amine materials,

to yield a novel process strategy

Silica-Supported Amine Sorbents

Amine sorbents widely studied in academia – but little work on scalable contactors

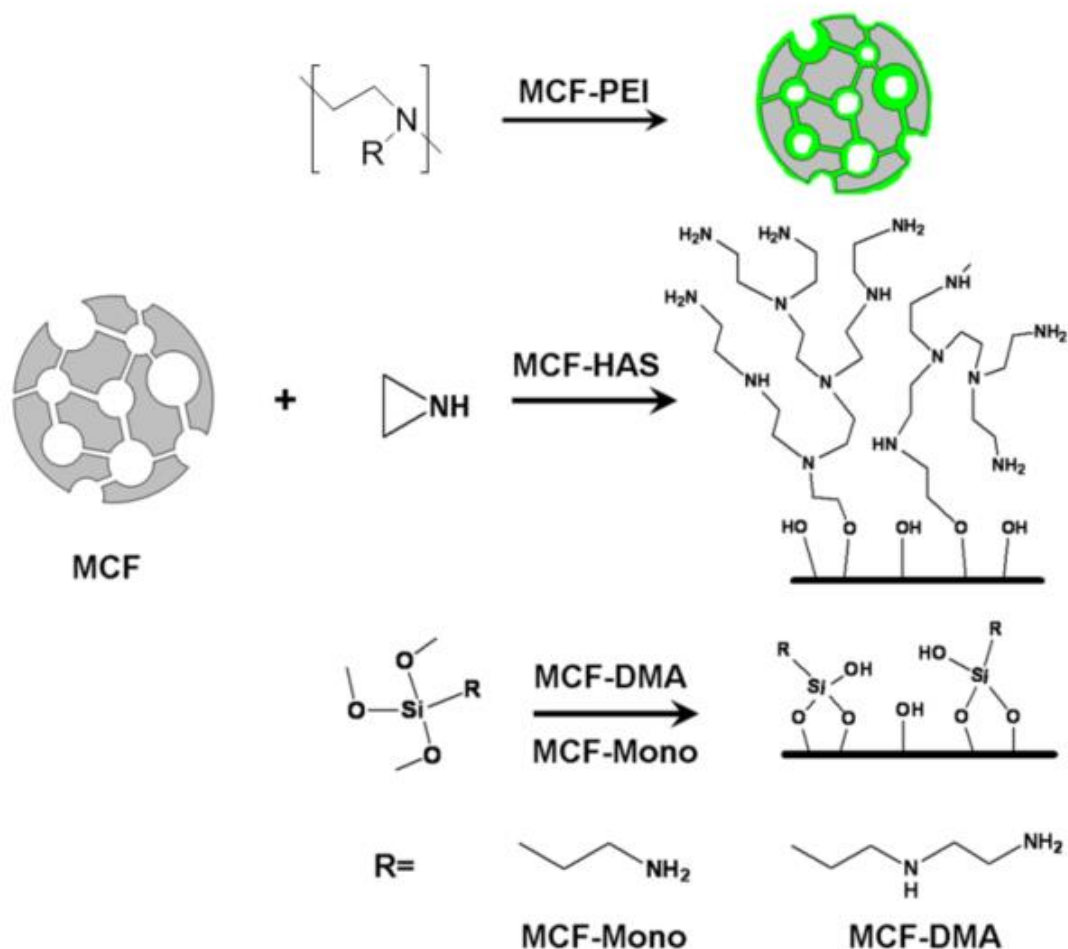

Class 1
Impregnated polymer

Class 3
In-situ Polymerized

Class 2
Grafted silanes

Supported amine sorbents require efficient heat management, $-\Delta H_S = 65\text{-}85 \text{ kJ/mol}$.

Hollow fiber sorbents: a mass producible structured sorbent inspired by hollow fiber membrane spinning

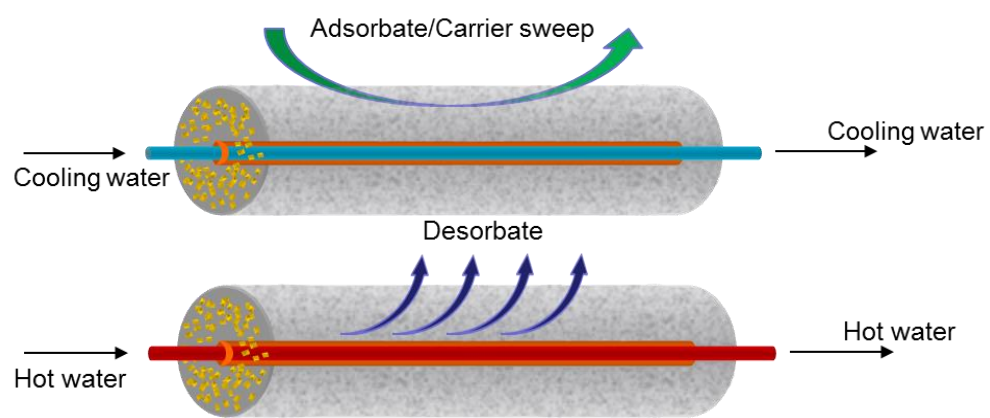
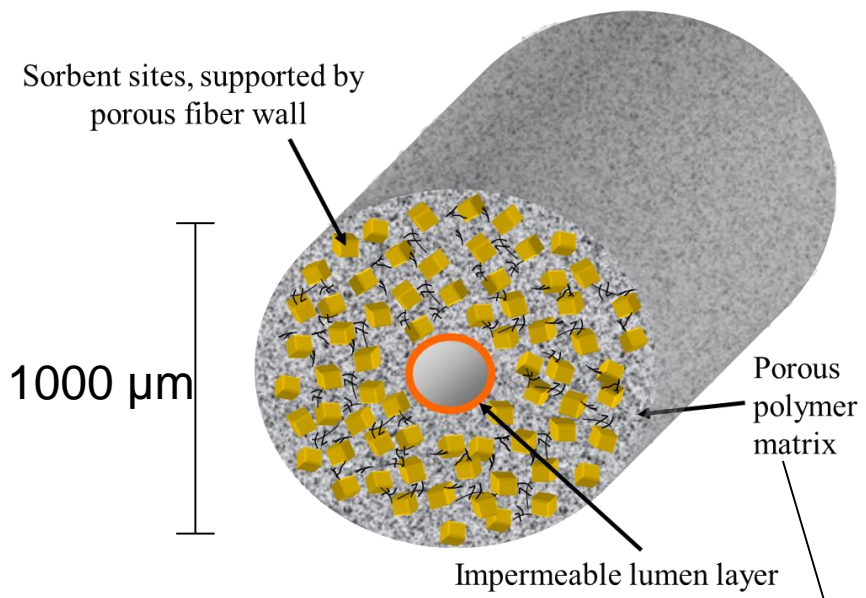

Ideal temperature swing adsorption

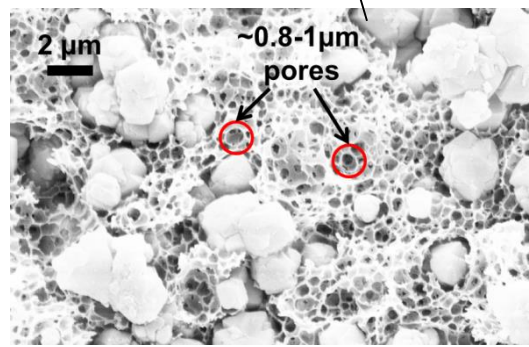
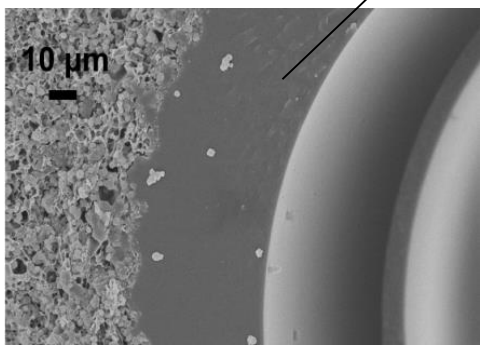

Bundle of 40 fibers in a 1.5' module at GT

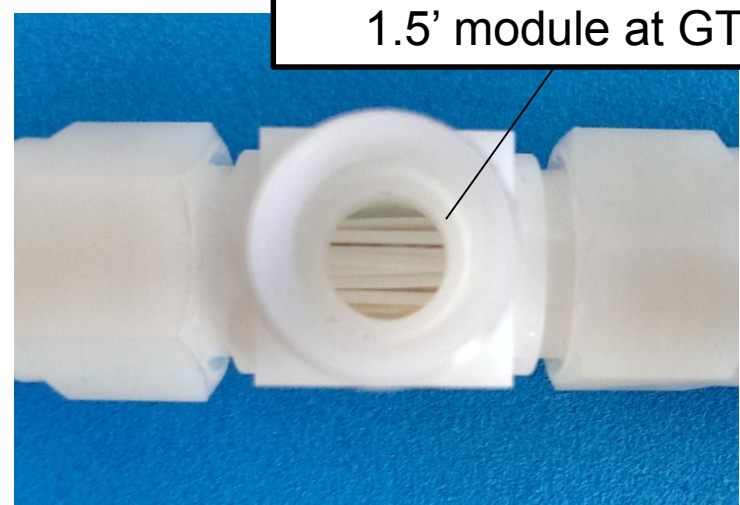

Hollow fiber sorbents: a mass producible structured sorbent inspired by hollow fiber membrane spinning

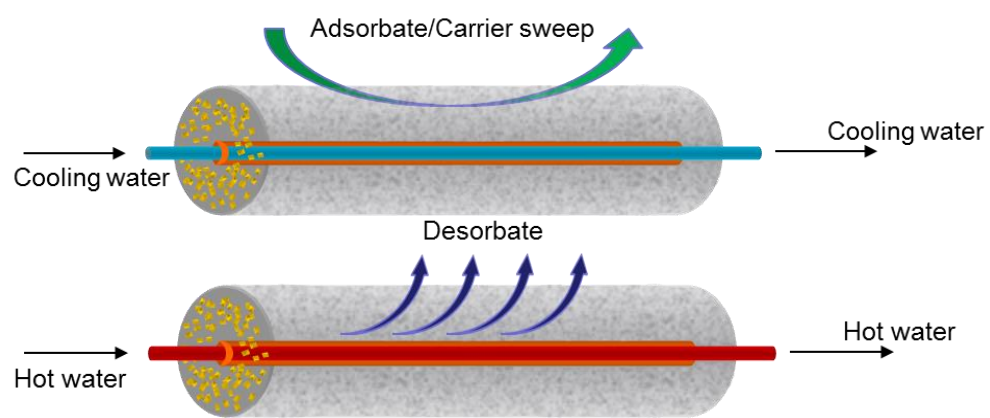
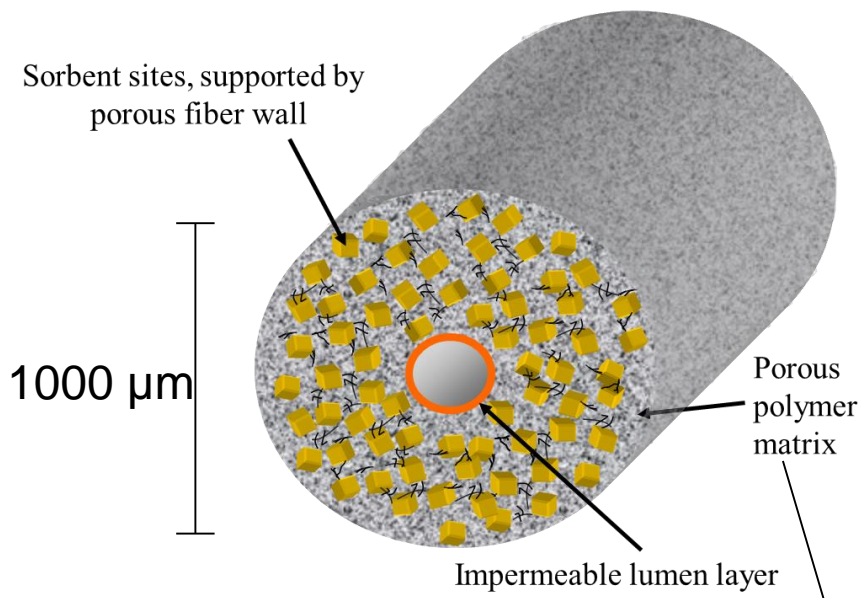

Ideal temperature swing adsorption

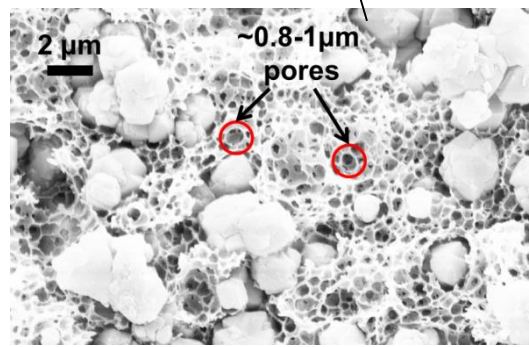
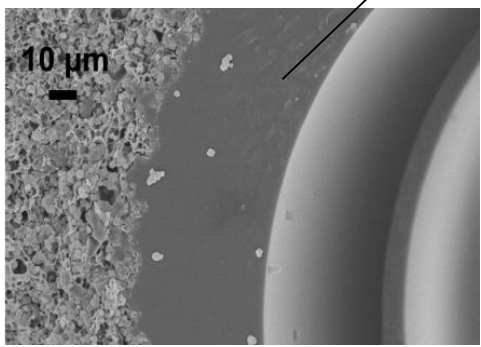

Large CO₂/CH₄ module
76 cm OD x 1.8 m
Used on 700 MMSCFD offshore platform
Courtesy, E. S. Sanders NAMS 2003 plenary

Rapid temperature swing adsorption (RTSA)

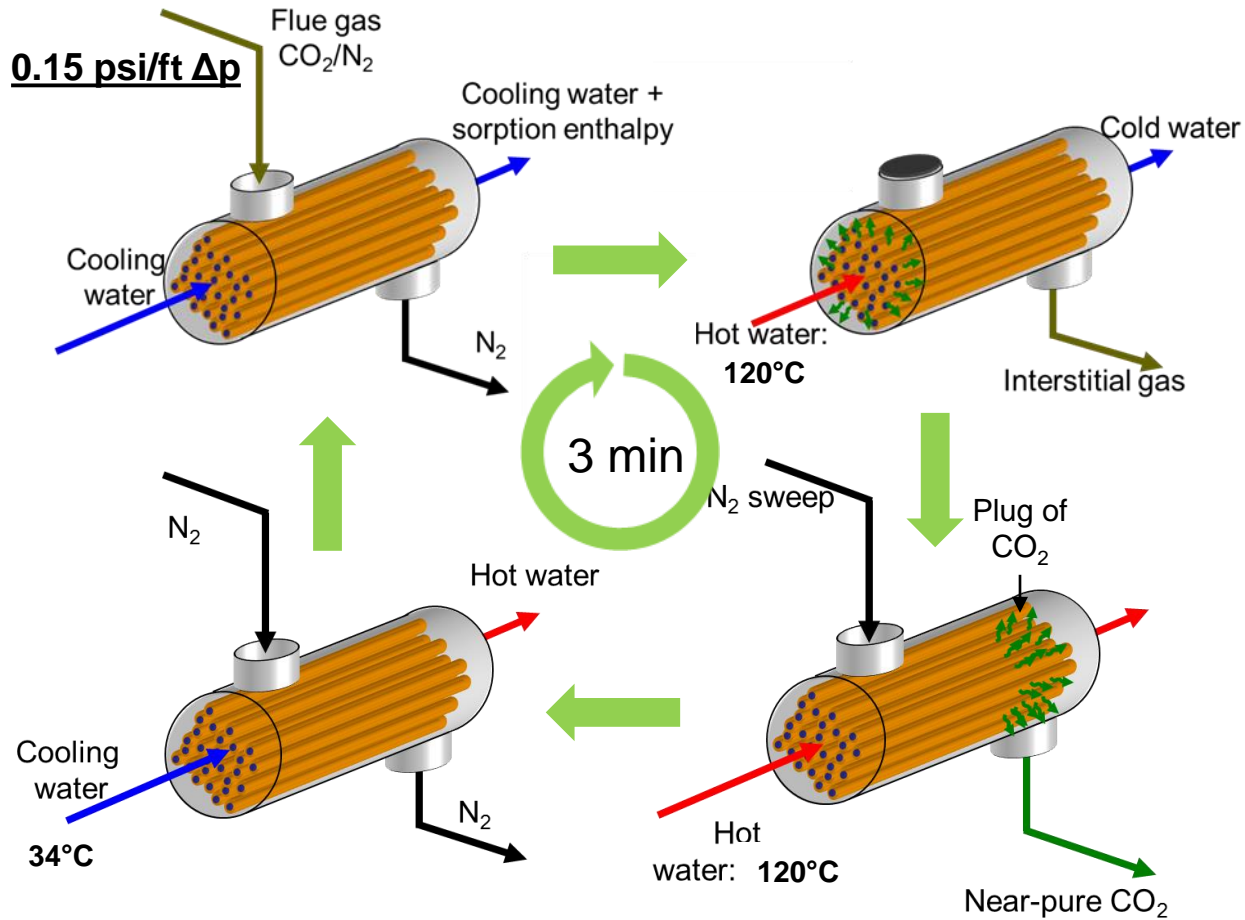

Rapid temperature swing adsorption (RTSA)

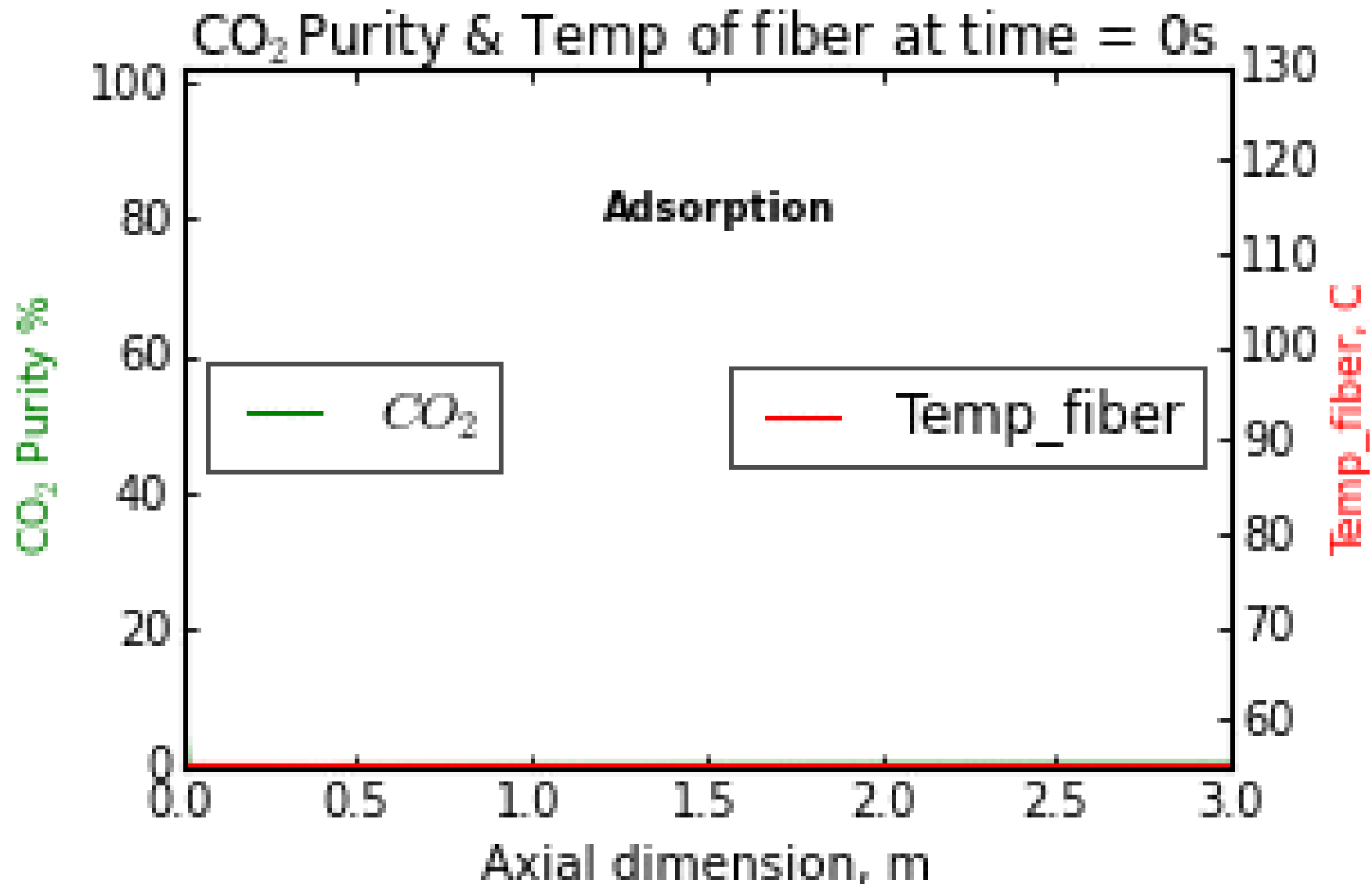

Rapid temperature swing adsorption (RTSA)

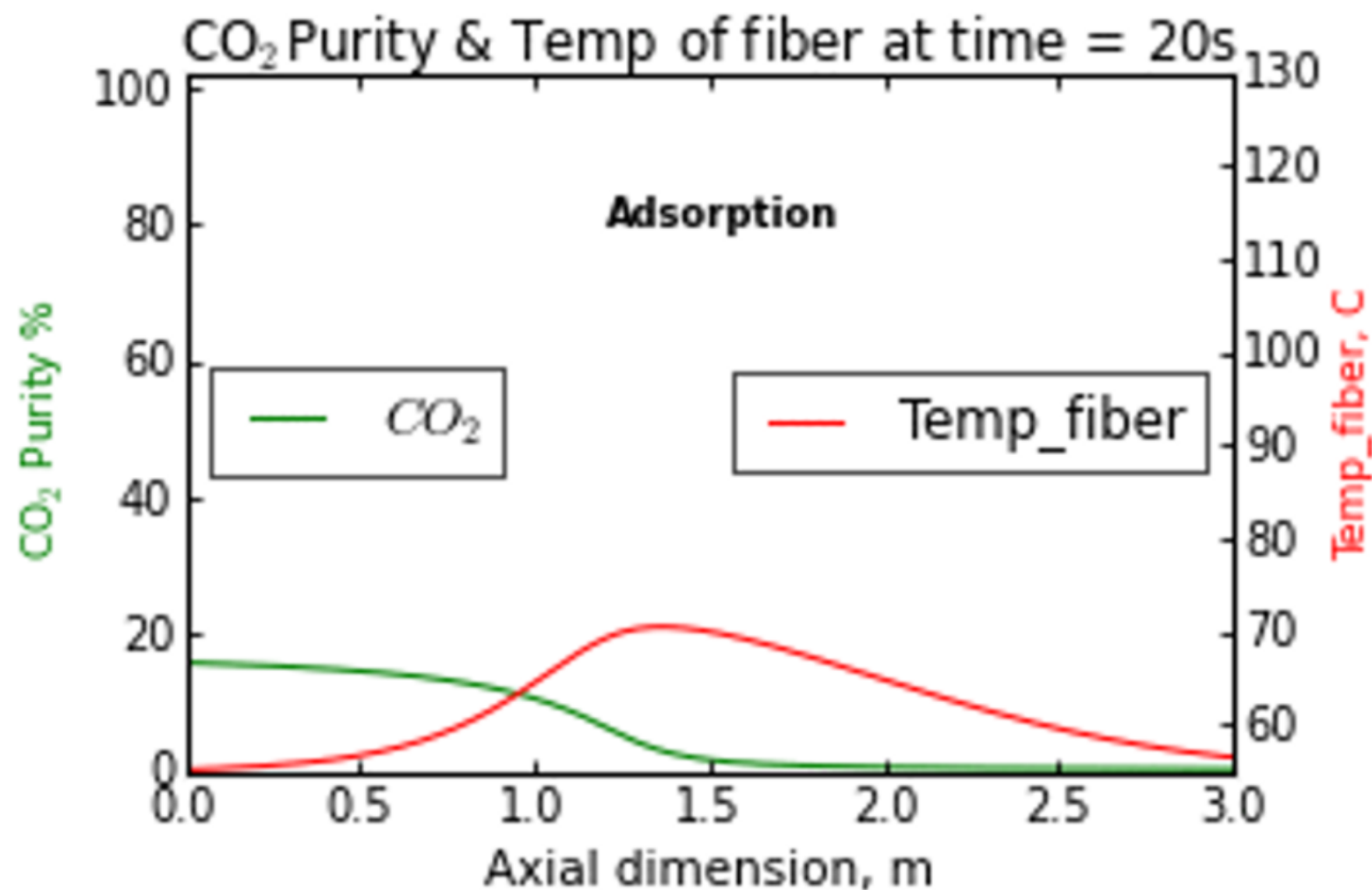

Rapid temperature swing adsorption (RTSA)

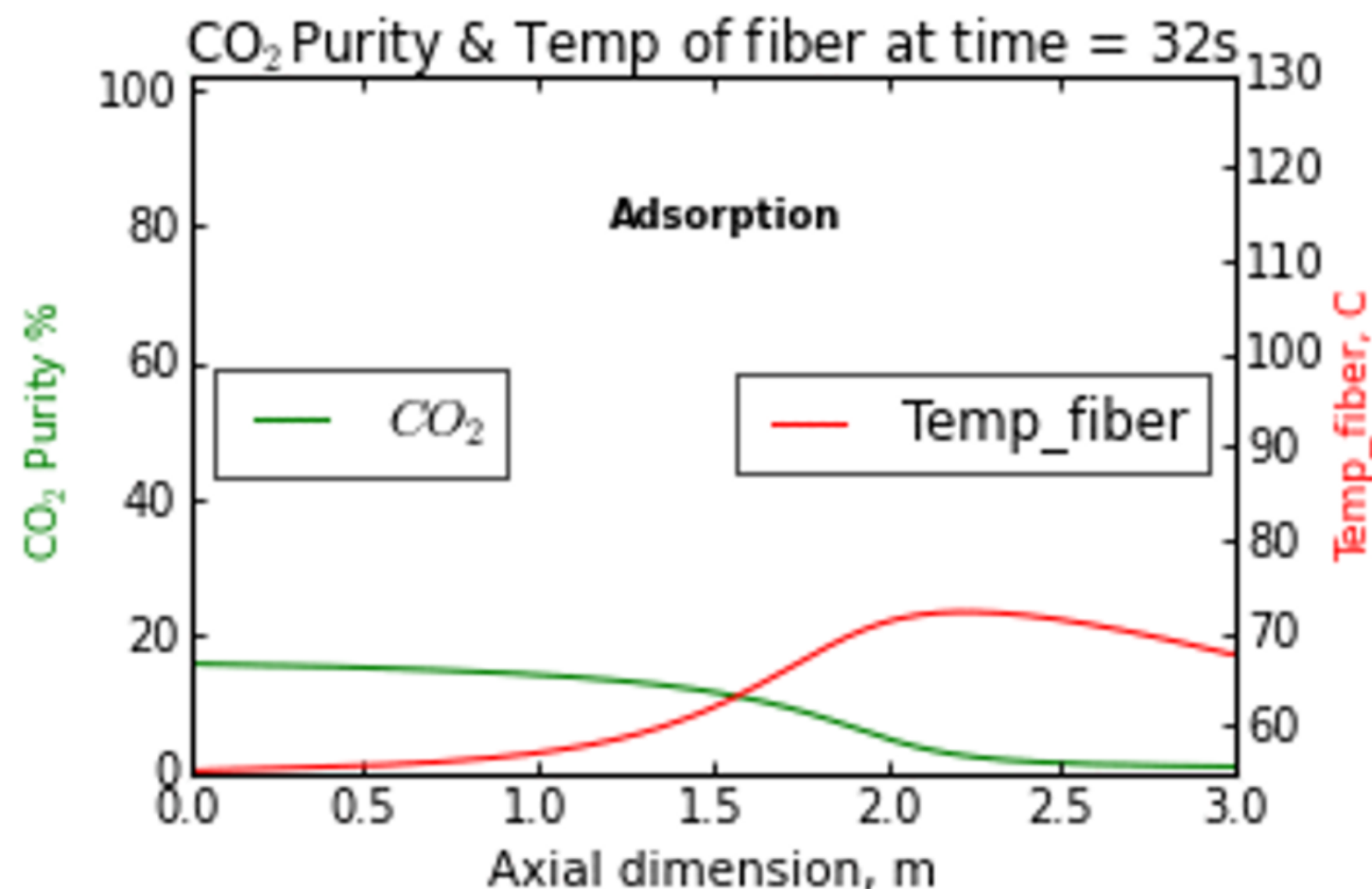

Rapid temperature swing adsorption (RTSA)

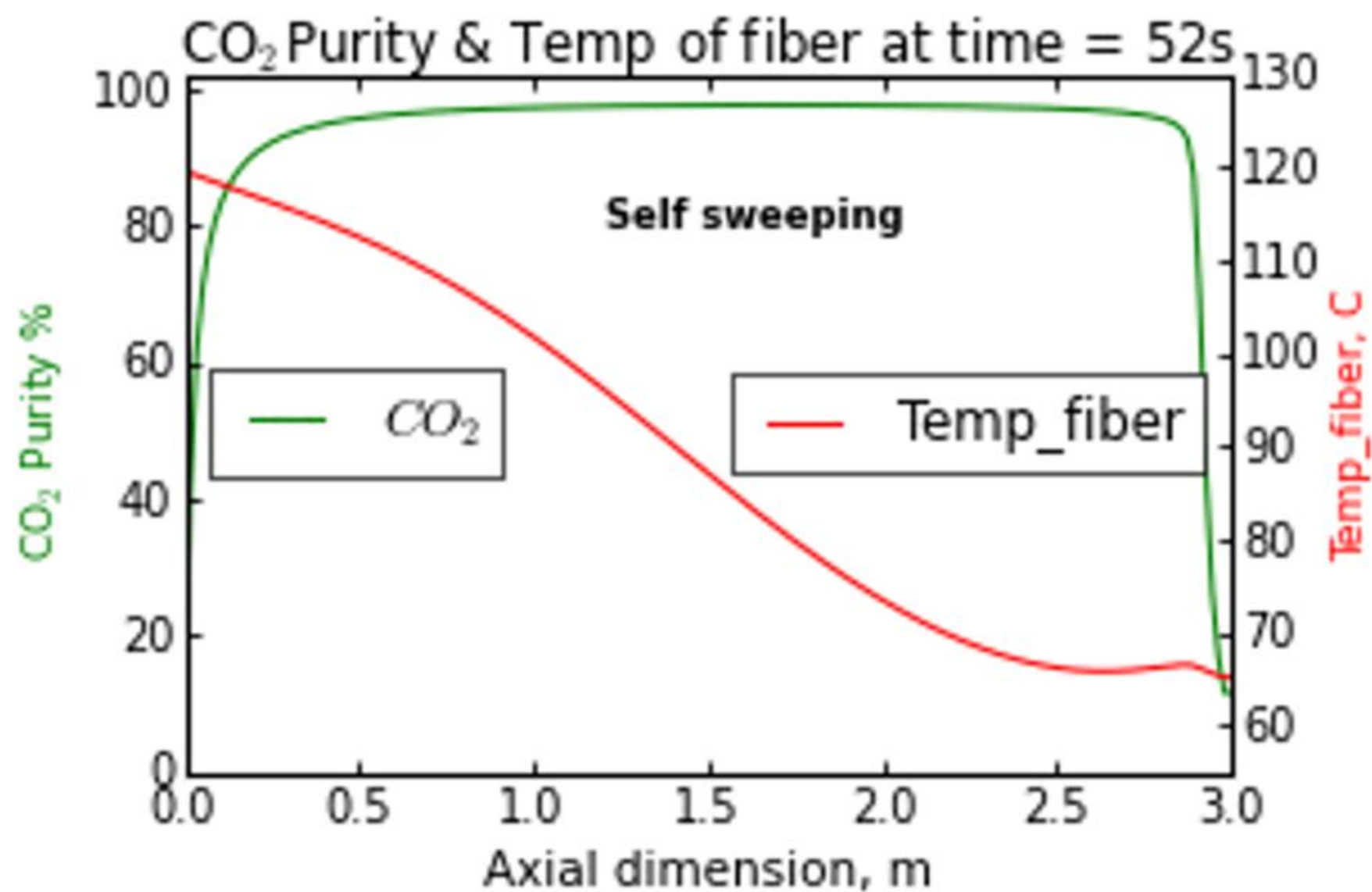

Rapid temperature swing adsorption (RTSA)

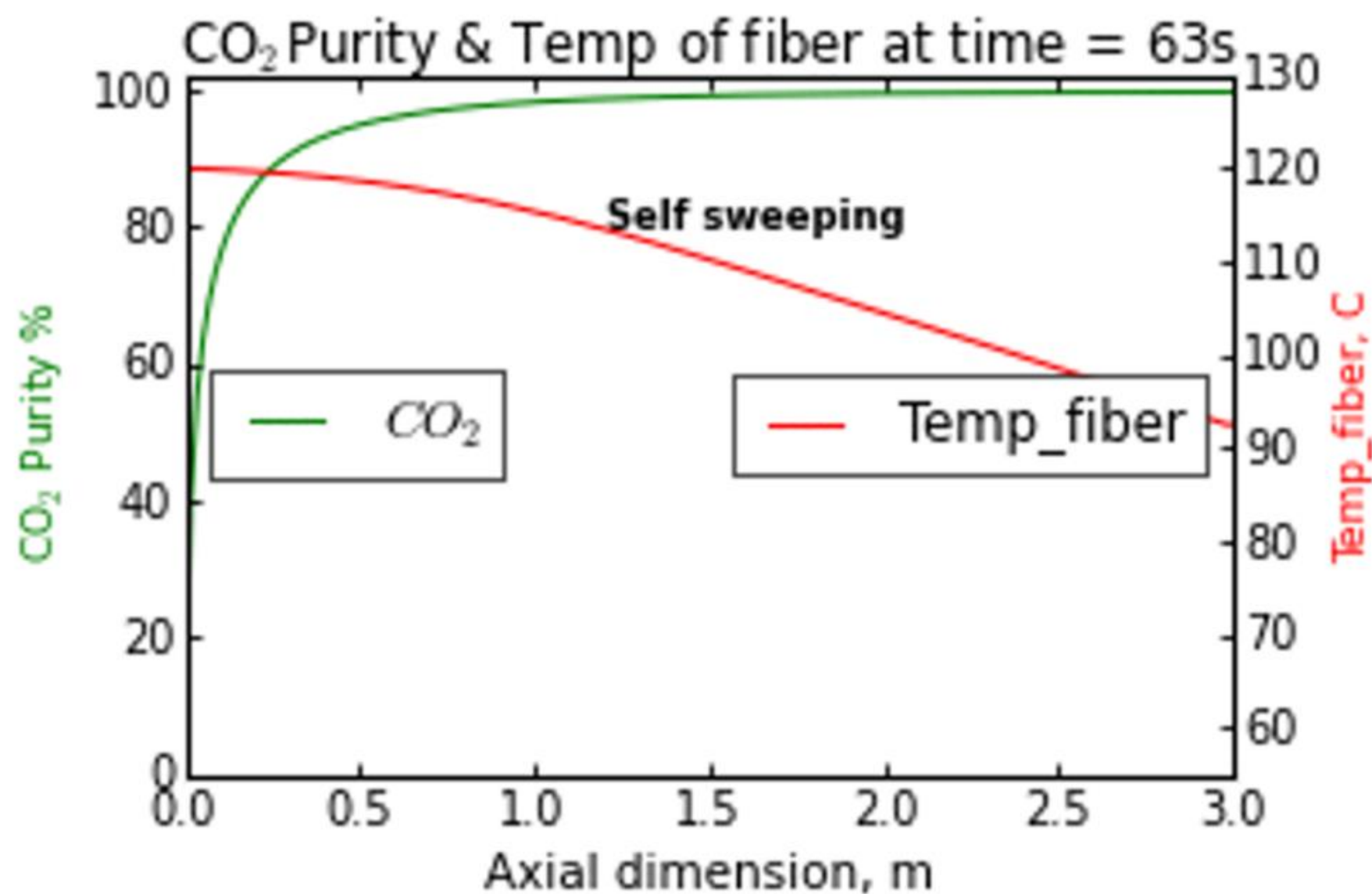

Rapid temperature swing adsorption (RTSA)

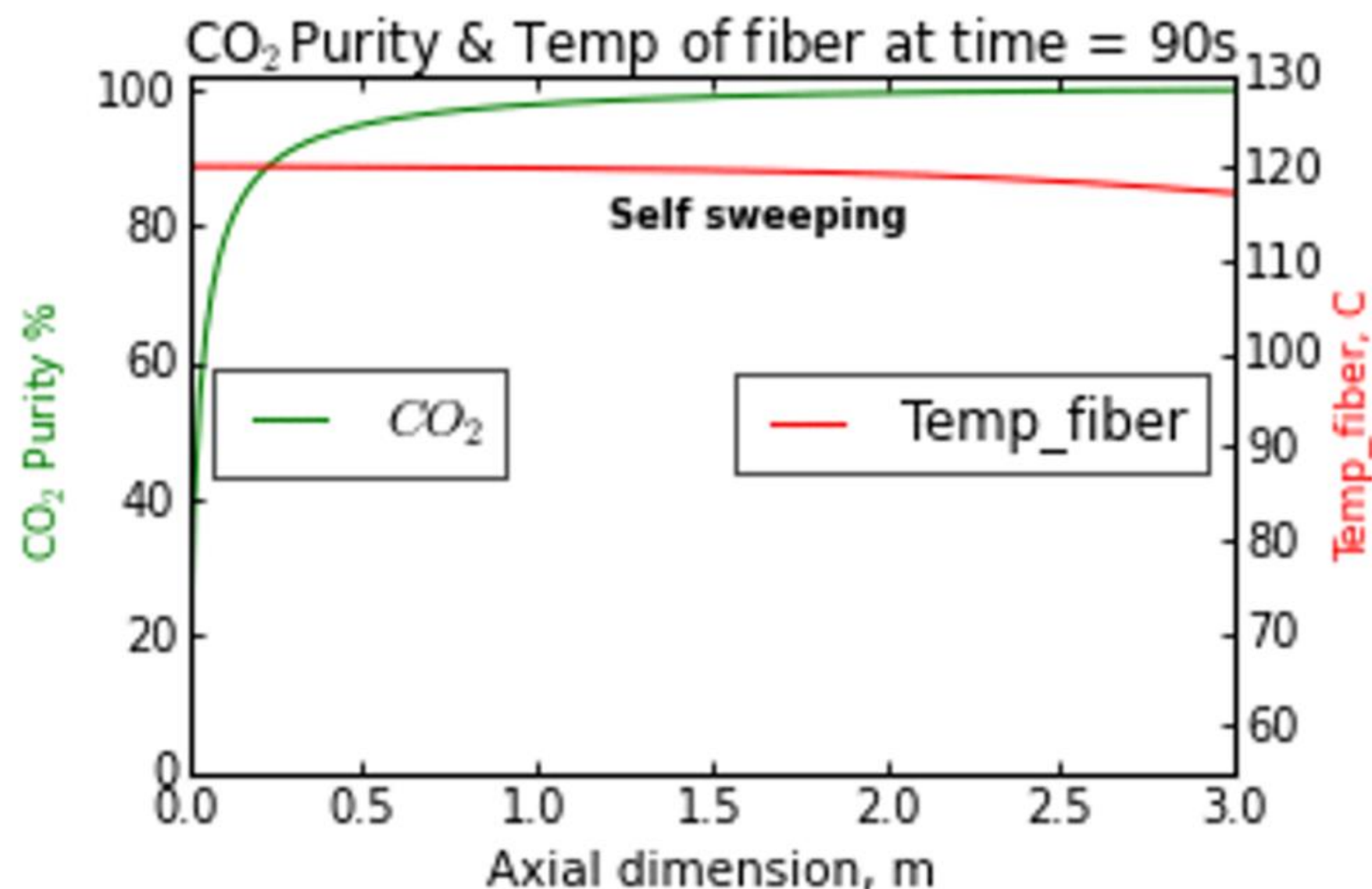

Rapid temperature swing adsorption (RTSA)

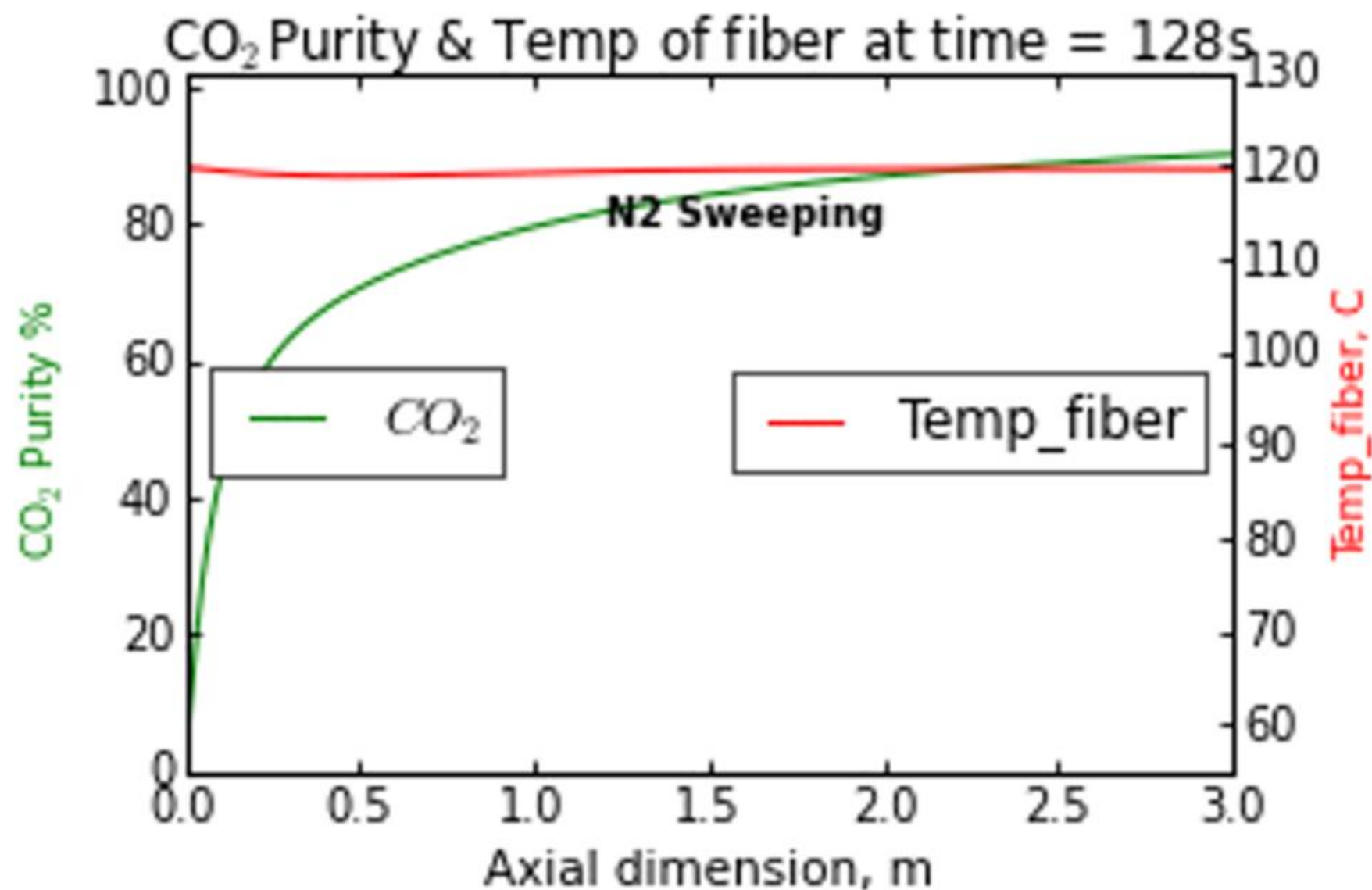

Rapid temperature swing adsorption (RTSA)

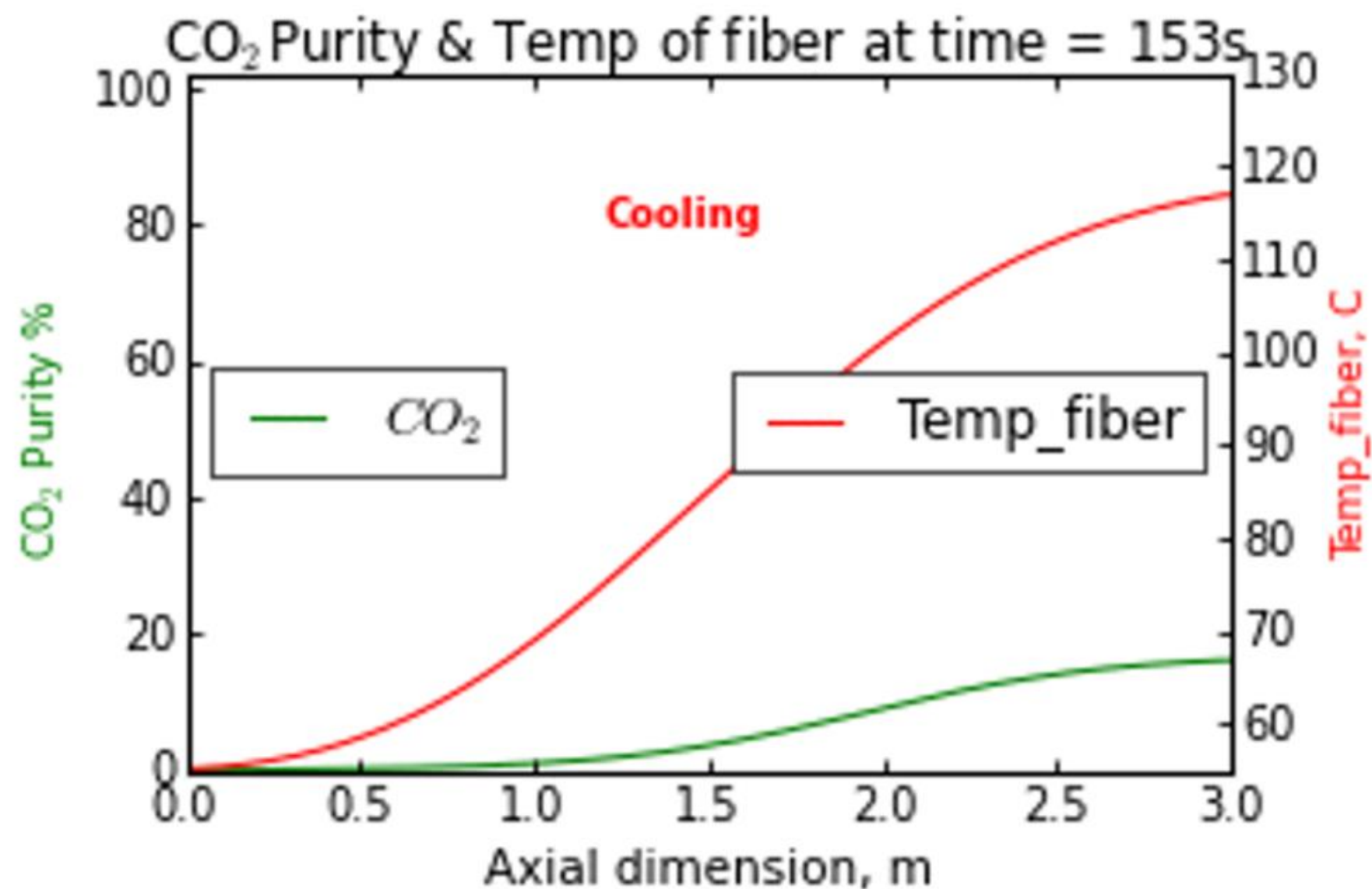

Rapid temperature swing adsorption (RTSA)

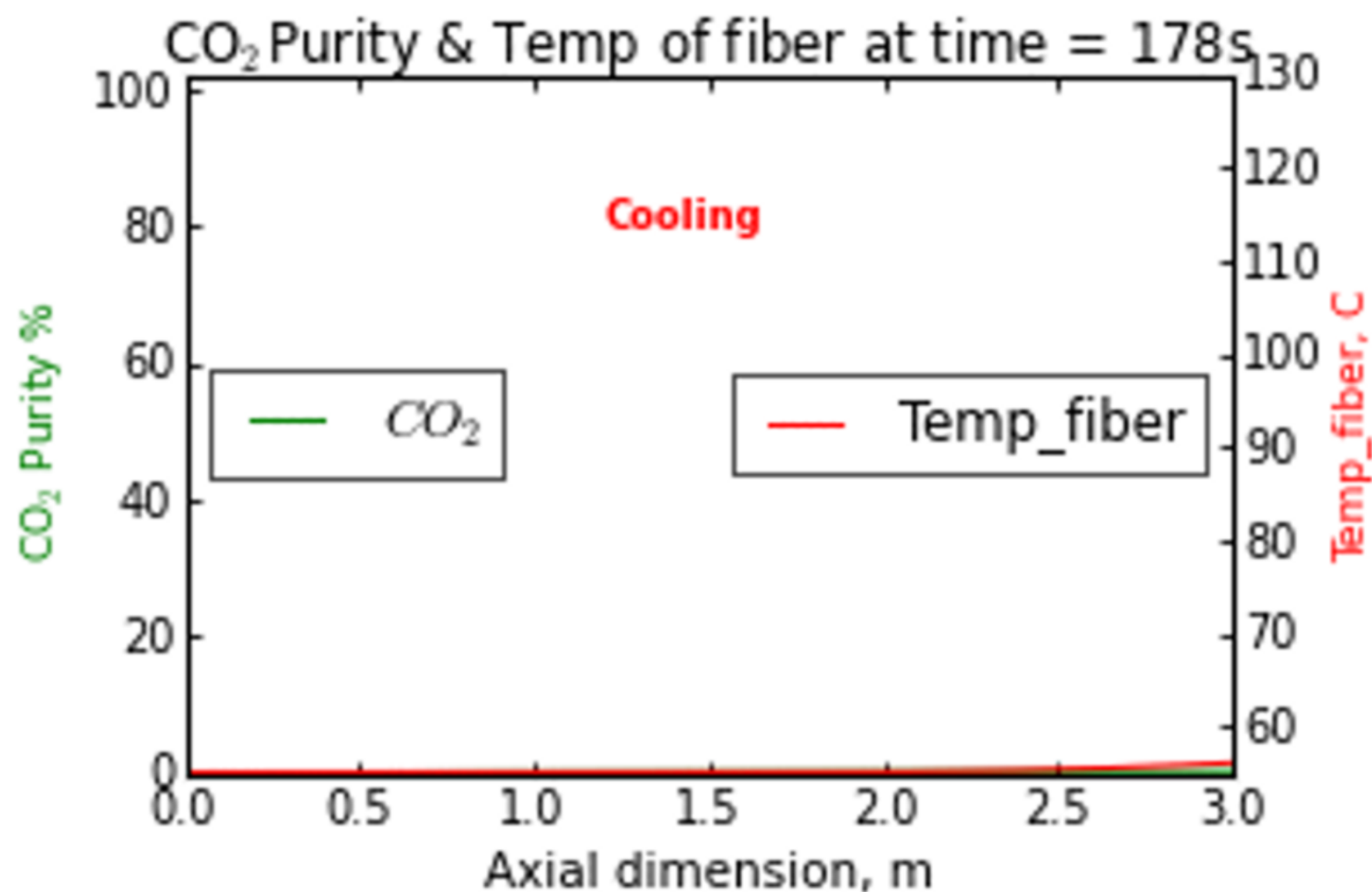

Creating the hollow fiber sorbents: Post-spinning amine infusion

New method for amine-containing fiber sorbent synthesis

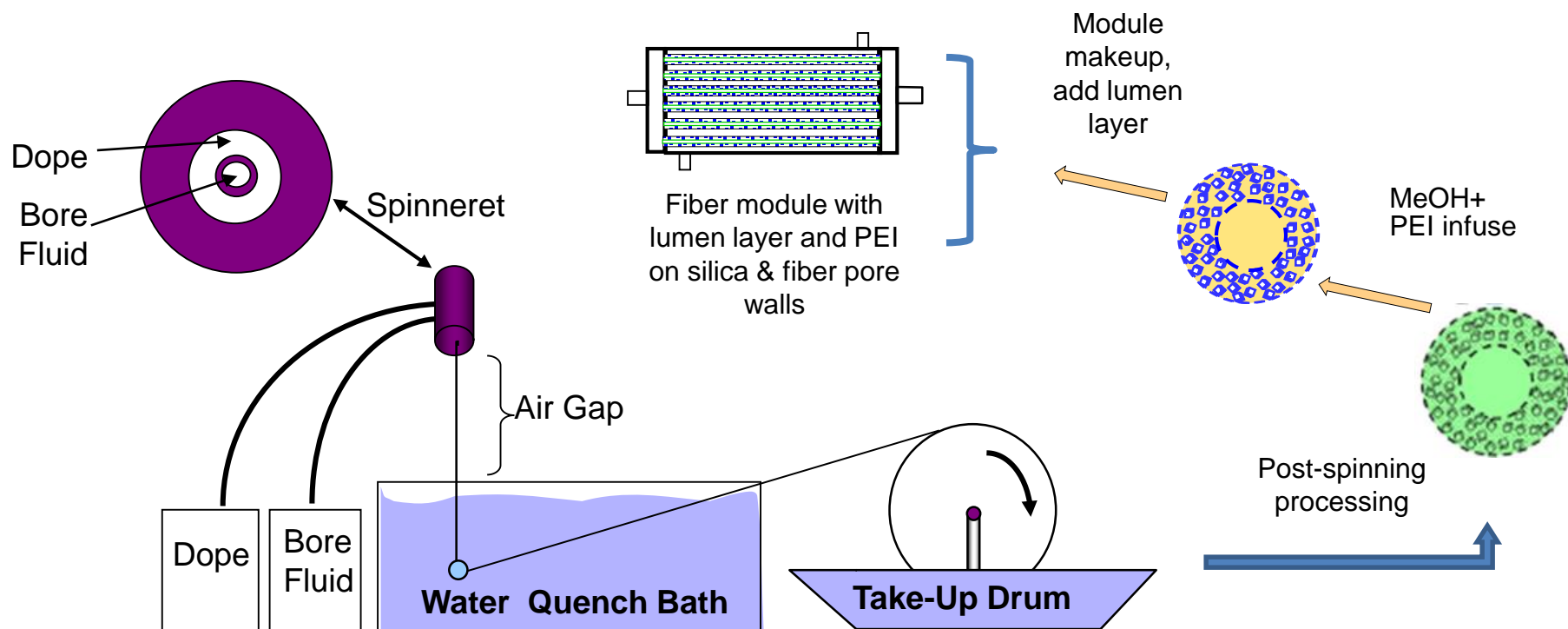

- First successful spinning of polymer/silica/PEI hollow fiber sorbent
- Simple, scalable procedure—does not appreciably change current solvent exchange procedure
- Proved the concept with cellulose acetate (CA) - CA/silica/PEI

Hollow Fiber Contactor as Heat Exchanger

Constructing a barrier lumen layer in the fiber bore allows the fibers to act as an adsorbing shell-in-tube heat exchanger.

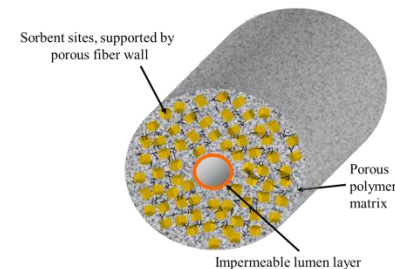

Two approaches:

(i) Post-treatment: Flow of a polymeric, Neoprene[®] latex and cross-linker through fibers

- Disadvantage – fibers can become clogged by latex, requires careful handling of latex

(ii) Dual layer fiber spinning – spin the lumen layer when initial fiber formed

- Advantage – highly scalable synthesis when poly(amide-imide) like Torlon[®] employed

- Main fiber: porous Torlon[®] containing 50-60 wt% silica;
Lumen layer: dense Torlon[®]; post-treatment with PDMS gives excellent barrier properties

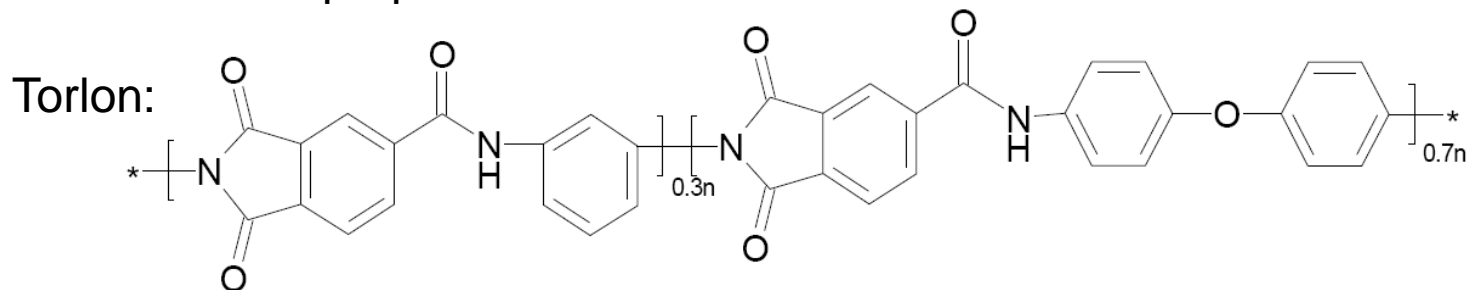

Hollow Fiber Contactor as Heat Exchanger

Constructing a barrier lumen layer in the fiber bore allows the fibers to act as an adsorbing shell-in-tube heat exchanger.

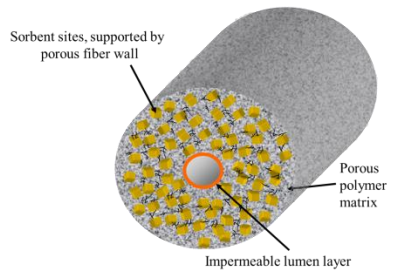

Two approaches:

(i) Post-treatment: Flow of a polymeric, Neoprene[®] latex and cross-linker through fibers

- Disadvantage – fibers can become clogged by latex, requires careful handling of latex

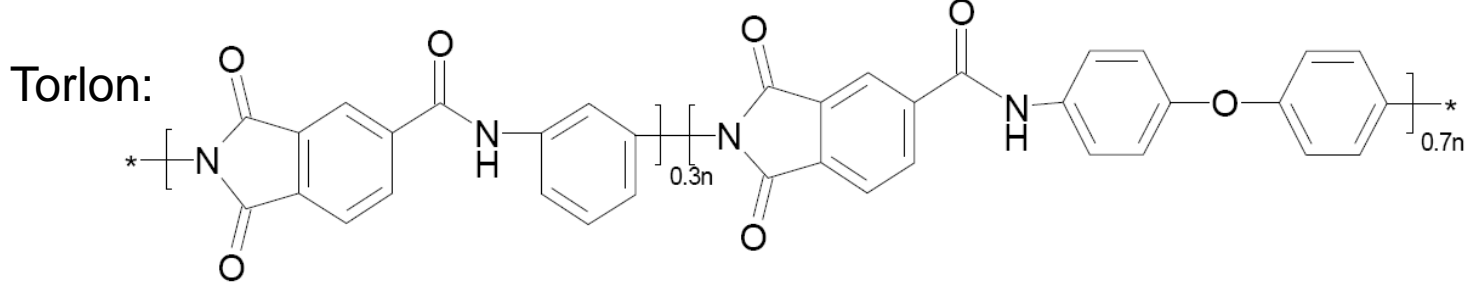
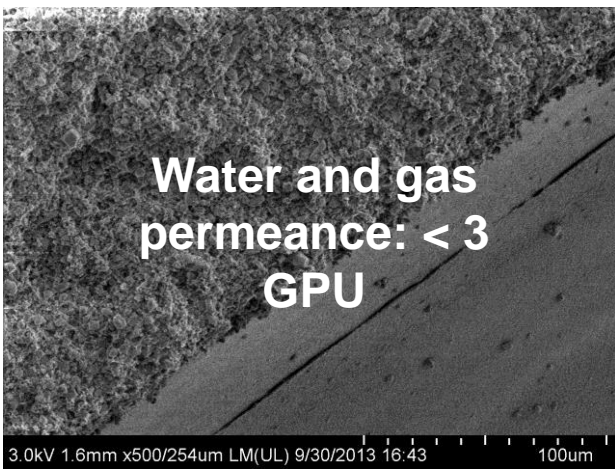
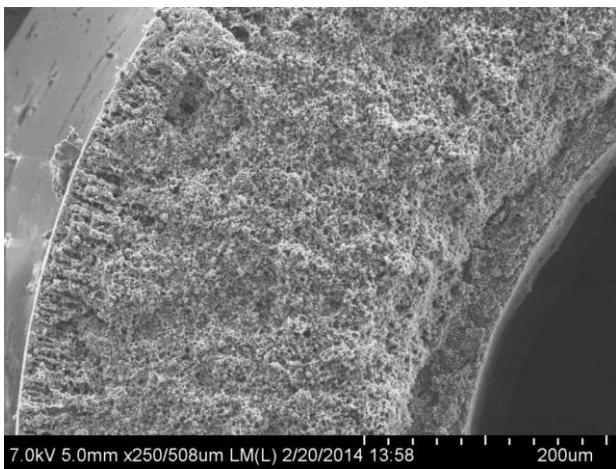
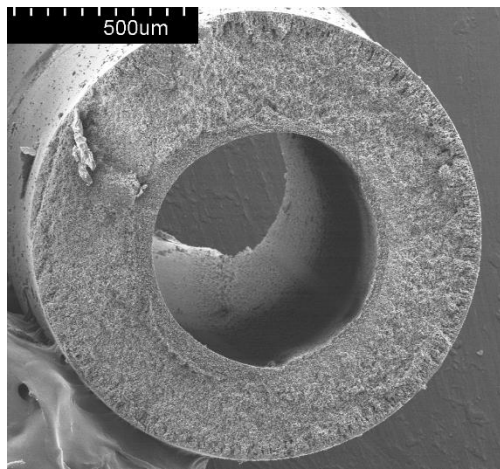

Lab-scale RTSA design and operation

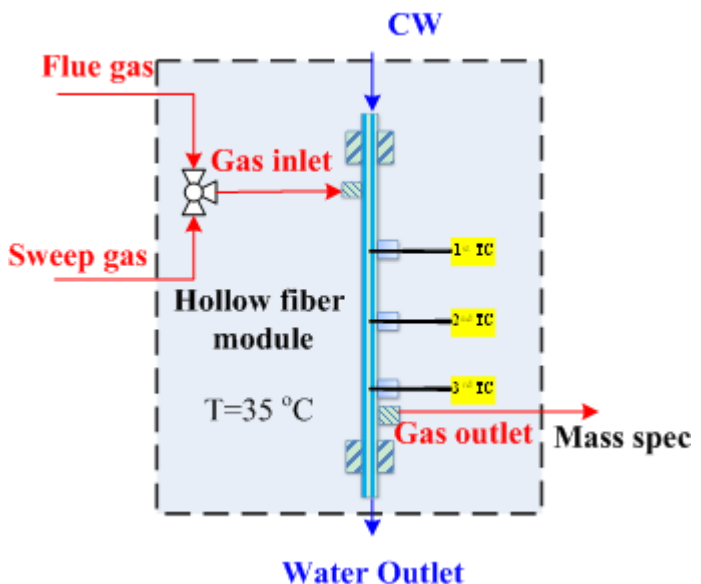
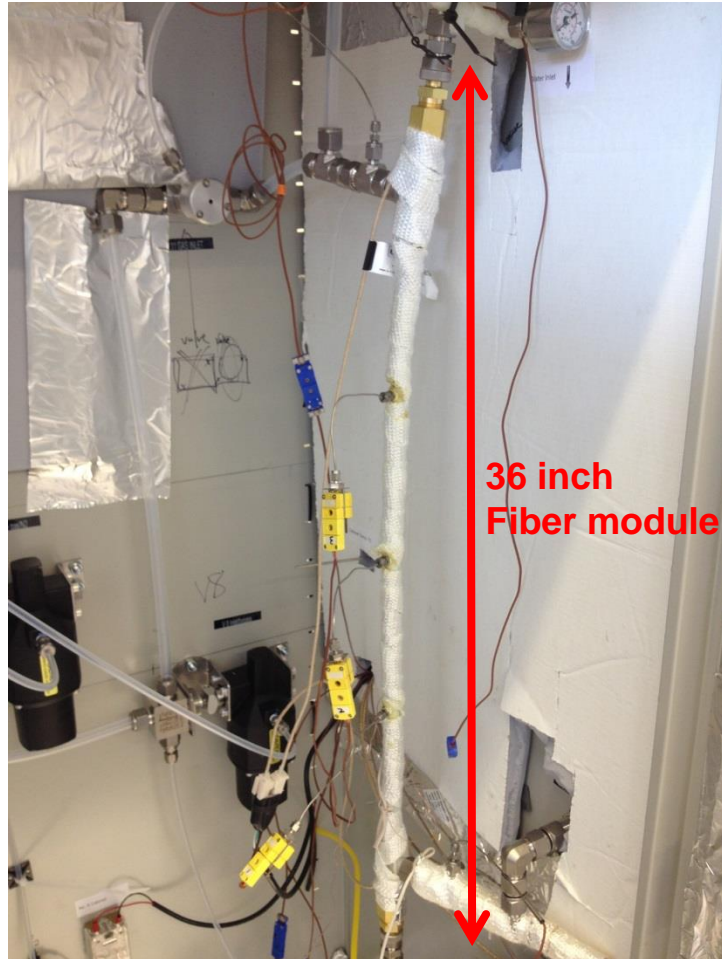
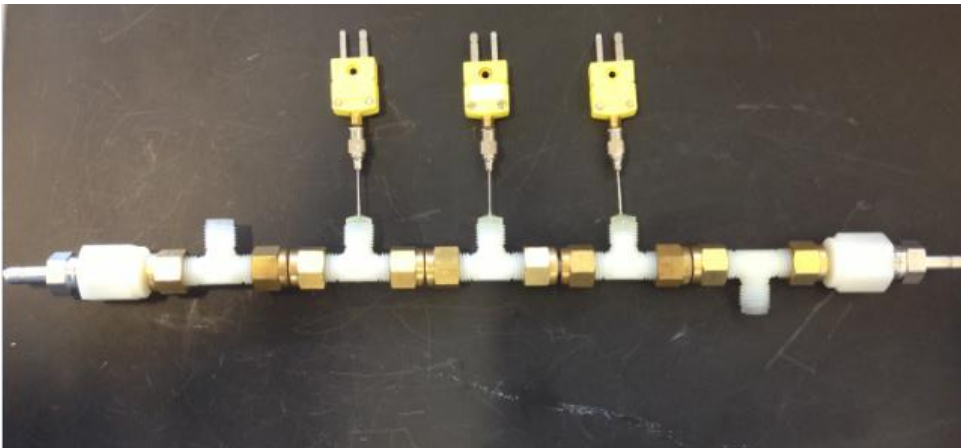

Flue gas composition: 35 °C, 1 atm
~ 13% CO₂, ~13% He (Inert tracer),
6% H₂O, balance gas N₂

q_b: breakthrough capacity

Cooled Torlon-C803-PEI Fiber Sorbent Generation 3 Fibers

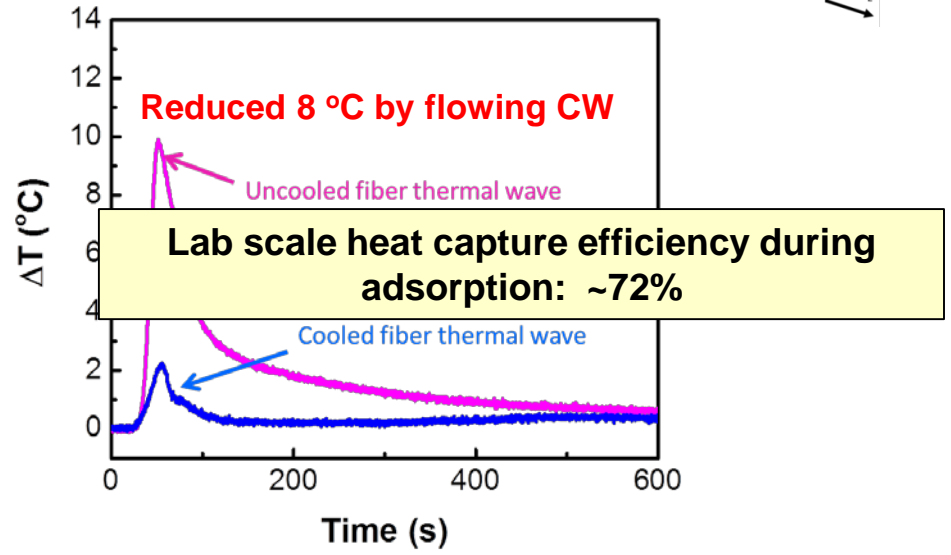
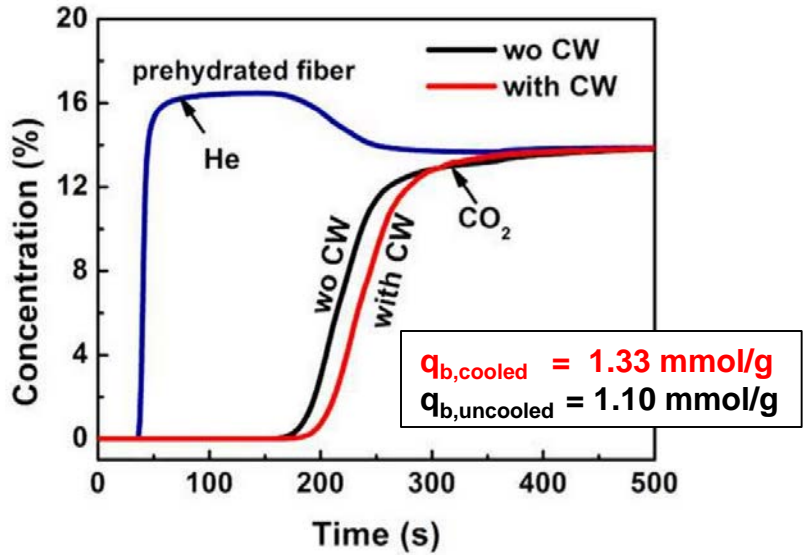
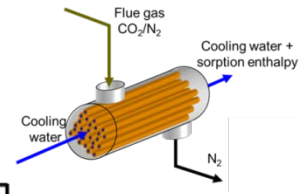

Gen. 2 fibers

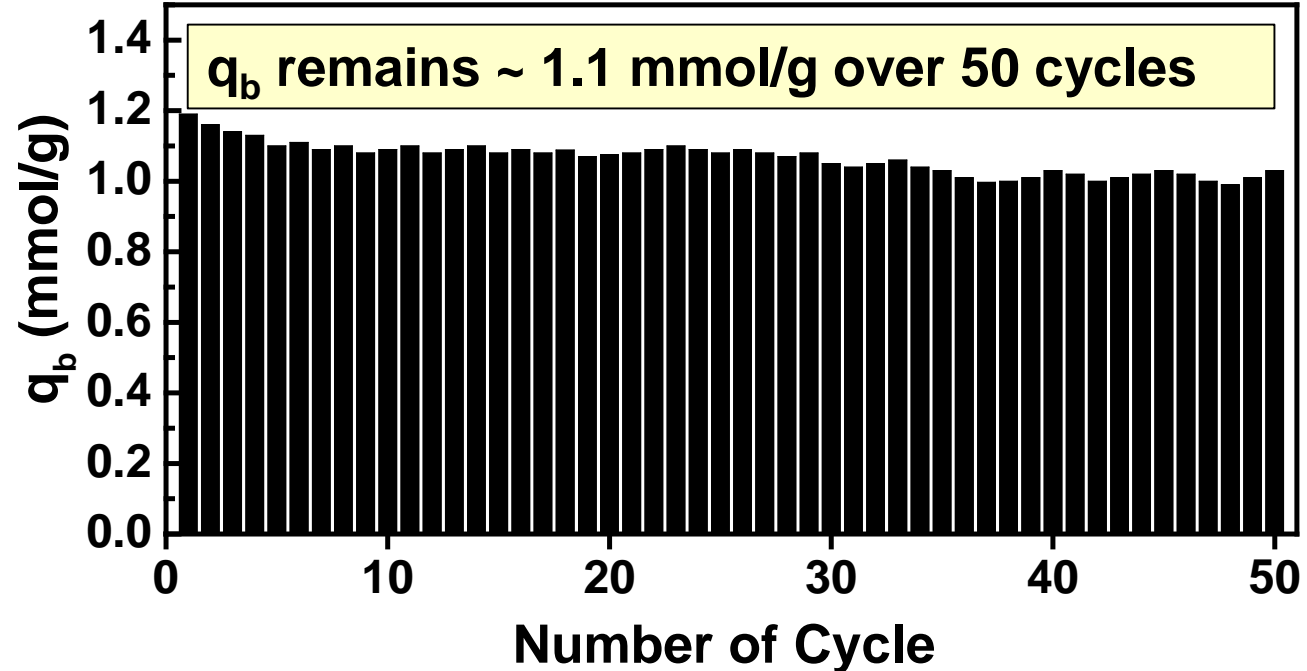

Gen. 3 fibers:
 $q_b \sim 1.4 \text{ mmol/g}$
 $q_{\text{swing}} \sim 0.85 \text{ mmol/g}$
 Target $q_s \sim 1 \text{ mmol/g}$

Impact of SO_x/NO_x on Fiber Module Operation

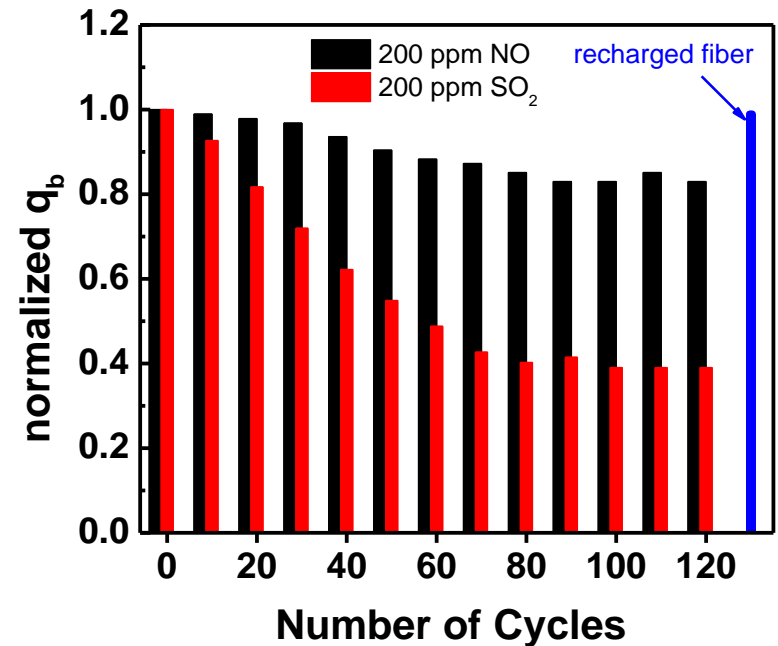
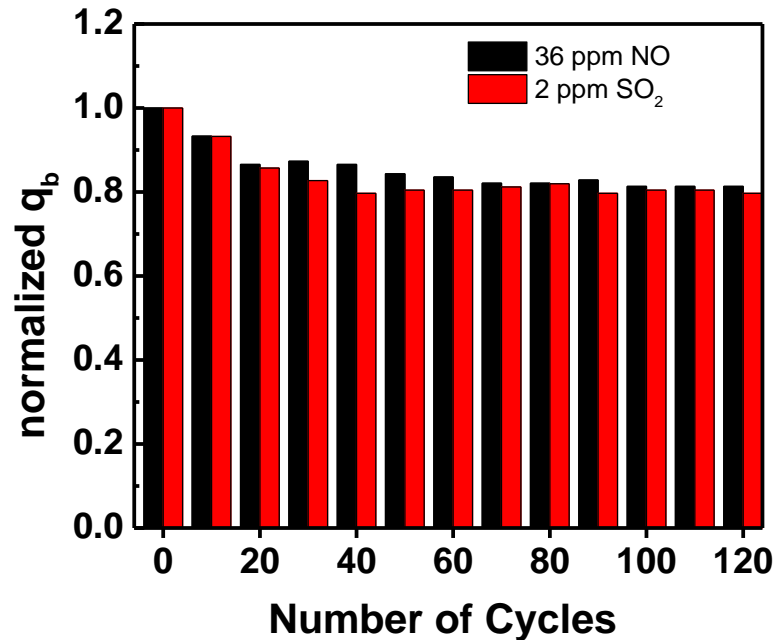

- **NO₂, SO₂** adsorb strongly, but have modest impact at low concentration
- Saturation capacity loss observed
- High concentration of gases (200 ppm) cause significant capacity loss, but a plateau was observed. Low concentration NO₂ had no measurable impact on capacity for class 1 fibers.
- Deactivated fibers can be stripped of amine and recharged in the field for **full capacity regeneration**.

Overall approach

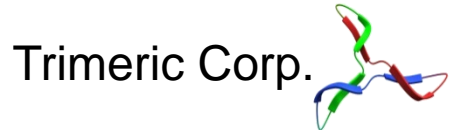

Cycle Design on Single Fiber (GT)

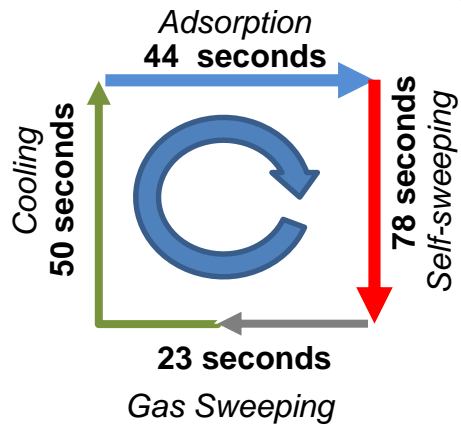

DOE Metric Calculation. Feedback to single fiber design and optimization

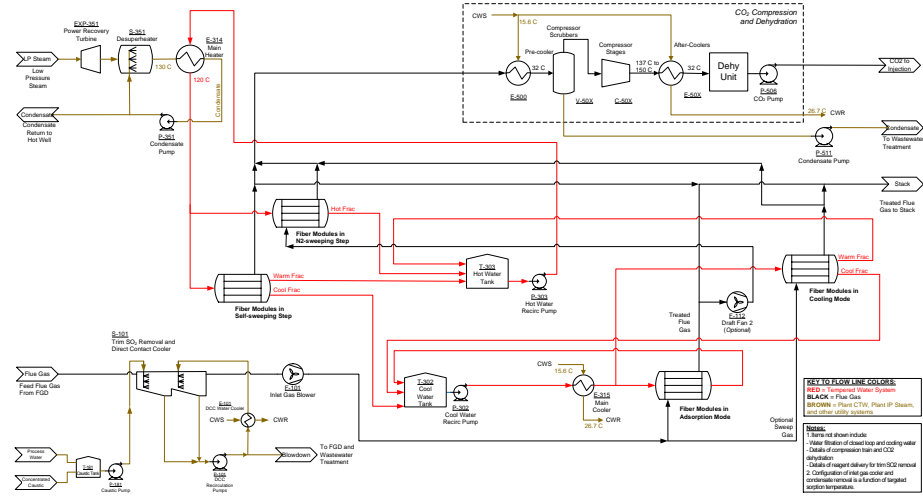

Cycle Model Validation and Scale Up to Module Level (GT and Trimeric)

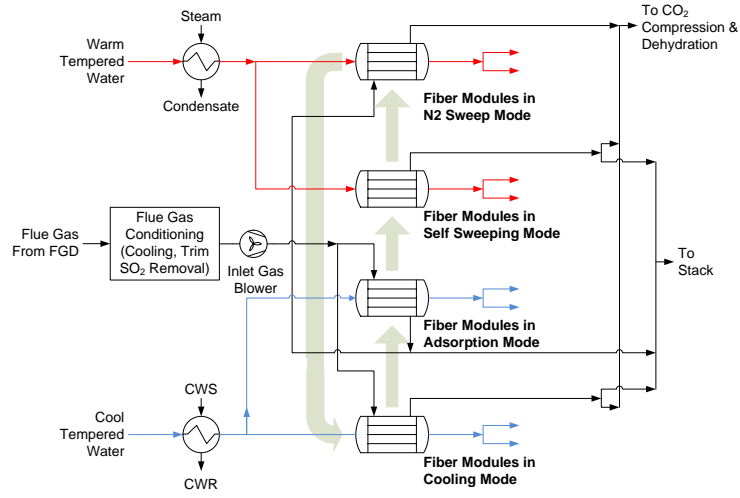

Water Looping for Heat Integration

Integration with Plant Design and Escalation for TEA (Trimeric)

Performance Evolution during Project and Future Directions

Description	Units	Year 2 Q4 (Sept 2013)	Year 3 (July 2014)	Year 3 (Jan 2015)
		RTSA	RTSA	RV TSA – 0.2 bar
Escalation Factor		1.67	1.53	1.40
Levelized Costs of Electricity and Steam				
Levelized cost of electricity	mills/kWh	178	154	126
Levelized cost of steam	\$/1,000 lb	16.2	14.0	11.5
Cost of CO ₂ Capture				
Total Annual Cost of CO ₂ Capture	MM\$/year	277	302	237
Impact of CO ₂ Capture on Plant Efficiency				
Net Plant Efficiency without CO ₂ Capture (HHV)	%	39.3	39.3	39.3
Net Plant Efficiency with CO ₂ Capture (HHV)	%	22.0	25.6	28.8
Change in Net Plant Efficiency	%	-17.3	-13.7	-10.5

Future directions:

Process configuration	RV TSA adsorption heat recovery	RV TSA CA polymer and 1 µm silica sorbent	RV TSA New polymer and 4 µm silica sorbent	RV TSA New polymer and 500 nm silica
Swing capacity [mmol/gfiber]	0.48	0.65	0.76	0.93
Number of modules	2002	1278	1096	894
Annual cost of CO ₂ capture [MM\$/year]	182	201	181	159
CO ₂ recovery [%]	75	90	90	90
CO ₂ purity [%]	95	96	96	95
Escalation factor	1.35	1.35	1.33	1.31

Summary, Major Advances, and Remaining Challenges

- **Rapid Temperature Swing Adsorption (RTSA)** enabled by a new contactor combined with solid amine sorbents.
 - Cycle allows **quasi-isothermal adsorption with significant latent heat recovery** due to nanoscopic shell-tube heat exchanger design.
- We are developing a fundamentally new contactor with modern sorbents – significant advances in first three years.
- Technoeconomic analysis suggests targets for improvement.

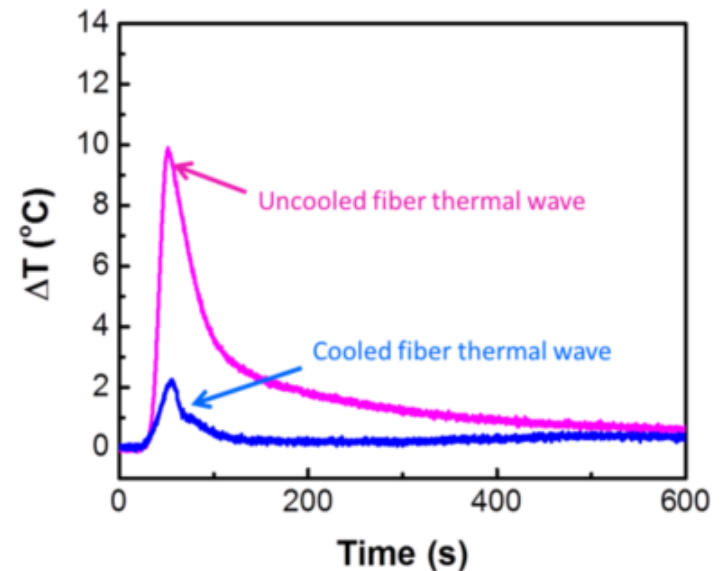
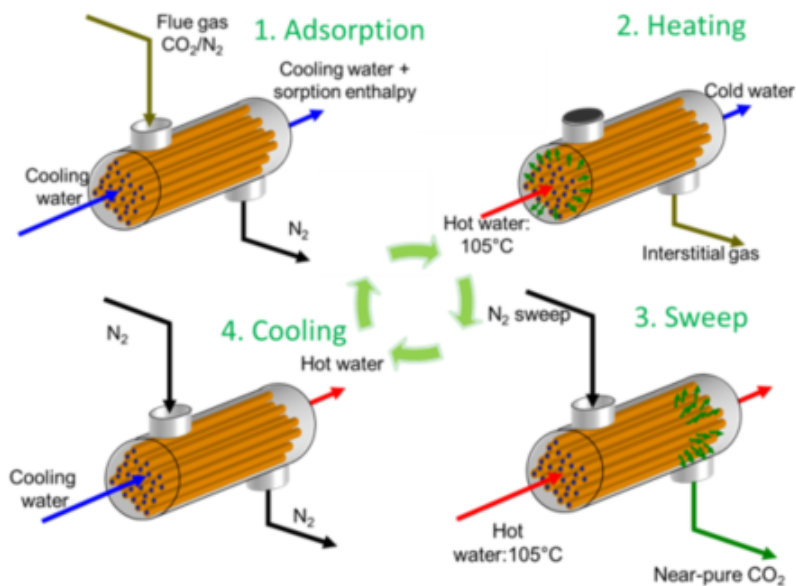

Summary, Major Advances, and Remaining Challenges

- Invention of post-spinning amine infusion method of creating and recharging sorbents
- Development of dual layer spinning method for scalable lumen layer formation
- Up to 70% recovery of the heat of adsorption via heat integration
- Detailed single fiber model validated with experiments
- Reduction of RTSA cycle times to 3 minutes
- Development of multi-scale model spanning the nanoscale to the plant scale, with rapid data transfer across scales

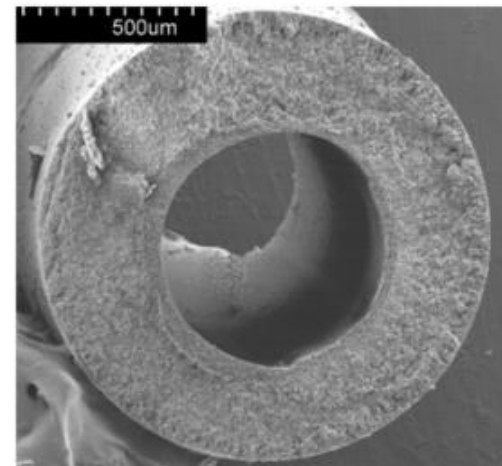
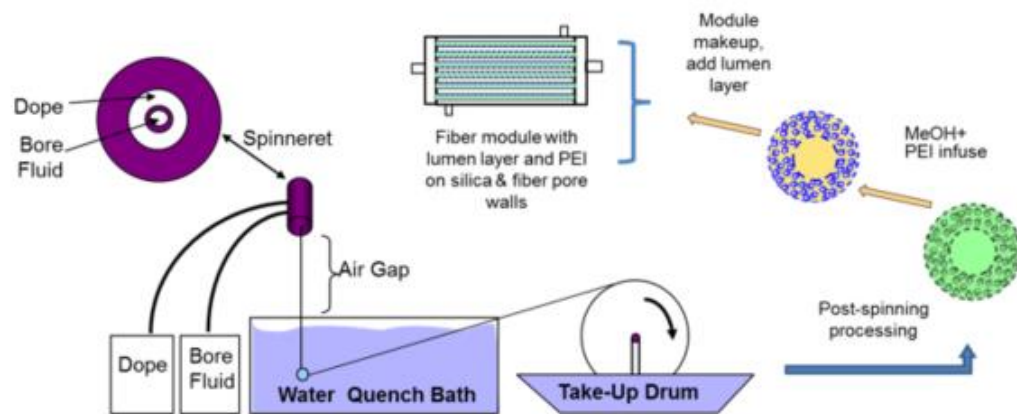

Summary, Major Advances, and Remaining Challenges

- Large scale, low cost process control (for practical operation, not for lab scale)
- Understanding dynamics by long term operation of complete cycles with bore-side heating/cooling
 - conducted >100 consecutive cycles with external heating/cooling
 - conducted <10 consecutive cycles with bore-side heating/cooling
- Complexities associated with water (humidity)
 - model results based on dry feeds
 - experimental tests with humidity conducted, humidity helps capacity and kinetics
- Incremental increases in breakthrough capacity
- Manufacturing cost estimates of fibers have significant uncertainty

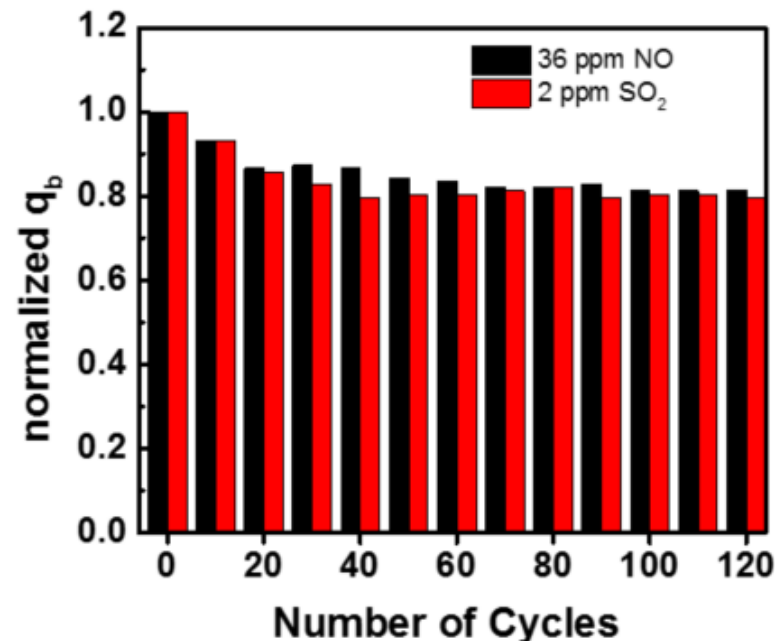

Publication and Inventions

Publications

1. Labreche, Ying., Lively, Ryan ; Rezaei, Fateme; Chen, Grace; Jones, Christopher W; Koros, William J., *Post-spinning infusion of poly(ethyleneimine) into polymer/silica hollow fiber sorbents for carbon dioxide capture*. Chemical Engineering Journal, 2013, 221, 166-175.
2. Rezaei, Fateme; Lively, Ryan; Labreche, Ying; Chen, Grace; Fan, Yanfang; Koros, William; Jones, Christopher, *Aminosilane-grafted polymer/silica hollow fiber adsorbents for CO₂ capture from flue gas*. ACS Applied Materials & Interfaces, 2013, 5, 3921-3931.
3. Rezaei, Fateme; Jones, Christopher, *Stability of Supported Amine Adsorbents to SO₂ and NO_x in Post-Combustion CO₂ Capture Process-1. Single Component Adsorption..* Industrial & Engineering Chemistry Research, 2013, 52, 12192-12201.
4. Fan, Yanfang; Lively, Ryan; Labreche, Ying; Rezaei, Fateme; Koros, William; Jones, Christopher, *Evaluating CO₂ dynamic adsorption performance of polymer/silica supported poly(ethylenimine) hollow fiber sorbents in rapid temperature swing adsorption*. International Journal of Greenhouse Gas Control, 2014, 21, 61-71.
5. Labreche, , Ying; Fan, Yanfang; Rezaei, Fateme; Lively, Ryan; Jones, Christopher; Koros, William, *Poly (amide-imide)/Silica Supported PEI Hollow Fiber Sorbents for Postcombustion CO₂ Capture by RTSA*. ACS. Appl. Mater. Interfaces, 2014, 6, 19336-19346.
6. Rezaei, Fateme; Jones, Christopher, *Stability of Supported Amine Adsorbents to SO₂ and NO_x in Post-Combustion CO₂ Capture Process-2. Multicomponent Adsorption..* Industrial & Engineering Chemistry Research, 2014, 53, 12103-12110.
7. Fan, Yanfang; Labreche, Ying; Lively, Ryan; Koros, William; Jones, Christopher, *Dynamic CO₂ Adsorption Performance of Internally Cooled Silica Supported Poly(ethylenimine) Hollow Fiber Sorbents*. AIChE J., 2014, 60, 3878-3887.
8. Rezaei, Fateme; Swernath, Subramanian; Kalyanaraman, Jayashree; Lively, Ryan; Kawajiri, Yoshiaki; Realf, Matthew, *Modelling of Rapid Temperature Swing Adsorption Using Hollow Fiber Sorbents*. Chem. Eng. Sci., 2014, 113, 62-67.
9. Kalyanaraman, Jayashree; Fan, Yanfang; Lively, Ryan; Koros, William; Jones, Christopher; Realf, Matthew; Kawajiri, Yoshiaki, *Modelling and Experimental Validation of Carbon Dioxide Sorption on Hollow Fibers Loaded with Silica-Supported Poly(ethylenimine)*. Chem. Eng. J., 2015, 259, 737-751.
10. Labreche, Ying; Fan, Yanfang; Lively, Ryan; Jones, Christopher; Koros, William, *Direct Dual Layer Spinning of Aminosilica/Torlon® Hollow Fiber Sorbents with a Lumen Layer for CO₂ Separation by Rapid Temperature Swing Adsorption*. J. Appl. Polym. Sci., 2015, 132, 4185.
11. Fan, Yanfang; Kalyanaraman, Jayashree; Labreche, Ying; Rezaei, Fateme; Lively, Ryan; Realf, Matthew; Koros, William; Jones, Christopher; Kawajiri, Yoshiaki, *CO₂ Sorption Performance of Composite Polymer/Aminosilica Hollow Fiber Sorbents*. Ind. Eng. Chem. Res., 2015, 54, 1783-1795.
12. Swernath, Subramanian; Searcy, Kathine; Rezaei, Fateme; Labreche, Ying; Lively, Ryan; Realf, Matthew; Kawajiri, Yoshiaki, *Optimization and Techno-Economic Analysis of Rapid Temperature Swing Adsorption (RTSA) Process for Carbon Capture from Coal-Fired Power Plant*. Comput. Aided Chem. Eng., 2015, in press.
13. Add Jayashree's paper that is submitted.
14. Fan, Yanfang; Rezaei, Fateme; Labreche, Ying; Lively, Ryan P.; Koros, William J.; Jones, Christopher W. *Stability of Amine-based Hollow Fiber CO₂ Adsorbents to NO and SO₂*. Fuel, to be submitted 04/15.

Inventions

1. " Dual Layer Spinning with Lumen Layer PAI Polymer/Silica/PEI Hollow Fiber Sorbent for RTSA" submitted on 11/25/ 2013, The internal reference number is GTRC ID 6560. The invention is sponsored by GE and US DOE. Y. Labreche, W.J. Koros, R. P. Lively
2. "Novel Amine Post-Spinning Infused Polymer/Silica Composite Hollow Fiber Sorbents" submitted on 07/18/2012. The internal reference number is GTRC ID 6142. The invention is supported by GE and US DOE. Y. Labreche, W.J. Koros, R. P. Lively, F. Rezaei, G. Chen, C. W. Jones, D. S. Sholl